



UNIVERSIDADE DE
COIMBRA



Departamento de Física

DA UNIVERSIDADE DE COIMBRA

1 2 9 0



FACULDADE DE
CIÊNCIAS E TECNOLOGIA
UNIVERSIDADE DE
COIMBRA



DARQ
Departamento de
Arquitetura

DCT
Departamento de
Ciências da Terra

DCV
Departamento de
Ciências da Vida

DEC
Departamento de
Engenharia Civil

DEEC
Departamento de
Engenharia
Eletrotécnica e de
Computadores

DEI
Departamento de
Engenharia
Informática

DEM
Departamento de
Engenharia
Mecânica

DEQ
Departamento de
Engenharia Química

DF
Departamento de
Física

DM
Departamento de
Matemática

DQ
Departamento de
Química

OBSERVATÓRIO
Geofísico e
Astronómico

DARQ
Departamento de
Arquitetura

DCT
Departamento de
Ciências da Terra

DCV
Departamento de
Ciências da Vida

DEC
Departamento de
Engenharia Civil

DEEC
Departamento de
Engenharia
Eletrotécnica e de
Computadores

DEI
Departamento de
Engenharia
Informática

DEM
Departamento de
Engenharia
Mecânica

DEQ
Departamento de
Engenharia Química

DF
Departamento de
Física

DM
Departamento de
Matemática

DQ
Departamento de
Química

OBSERVATÓRIO
Geofísico e
Astronómico

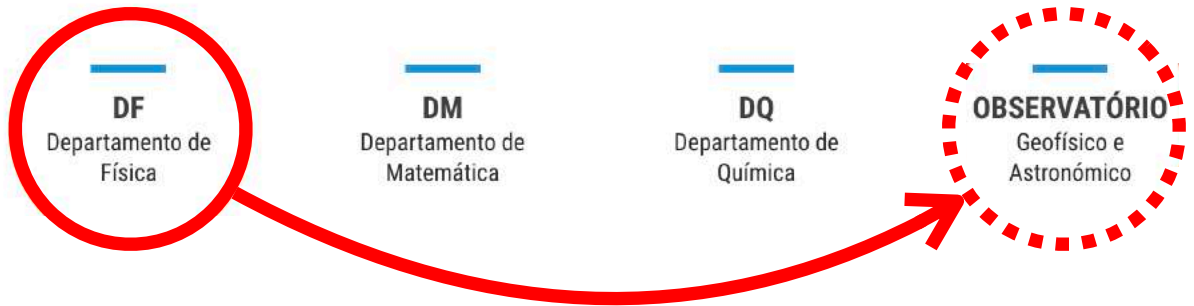

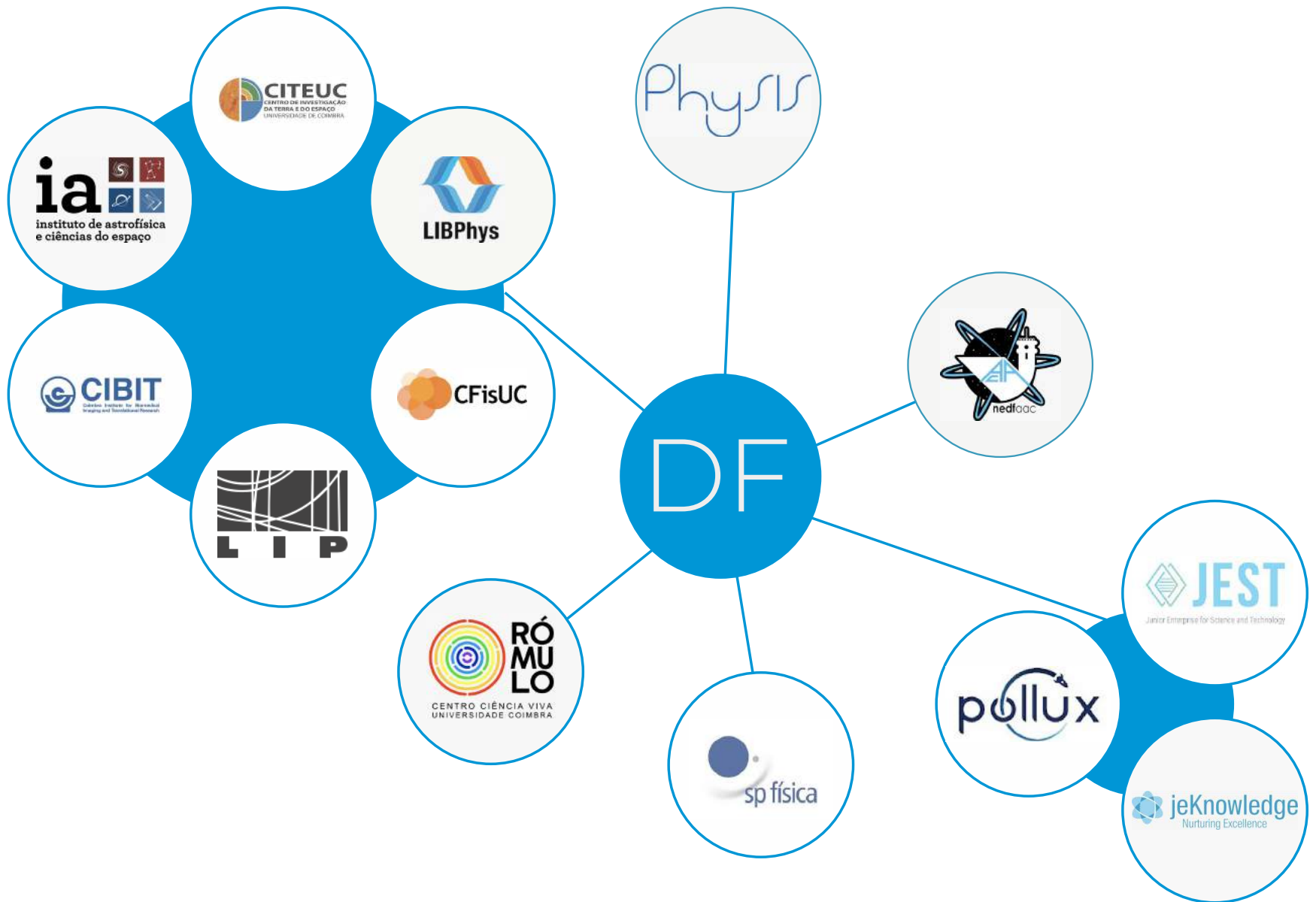

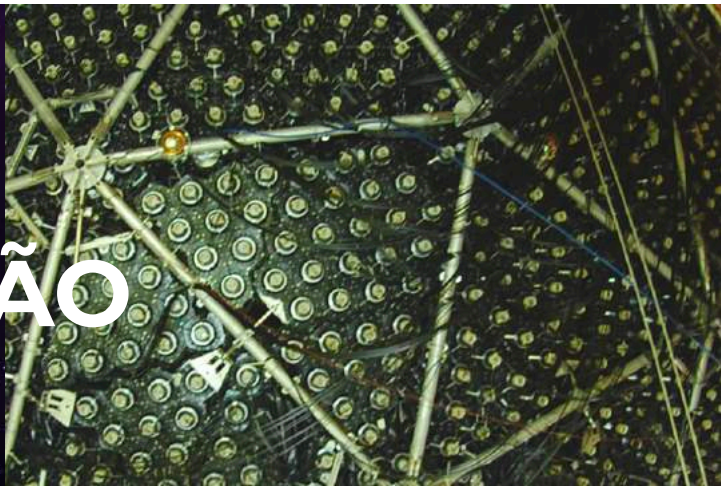
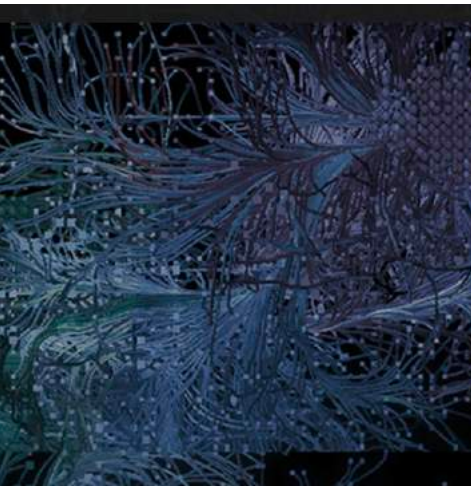
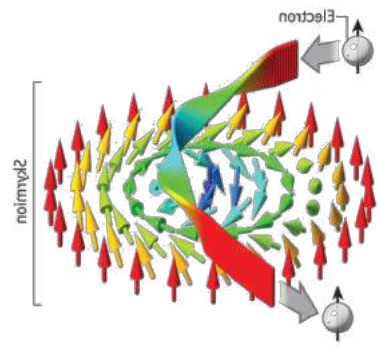
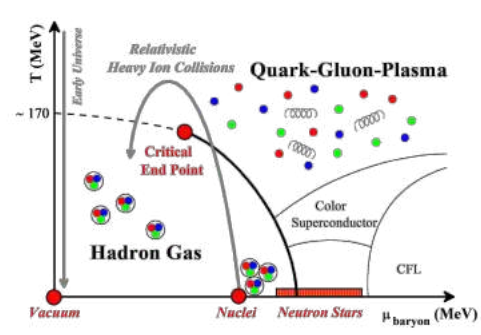
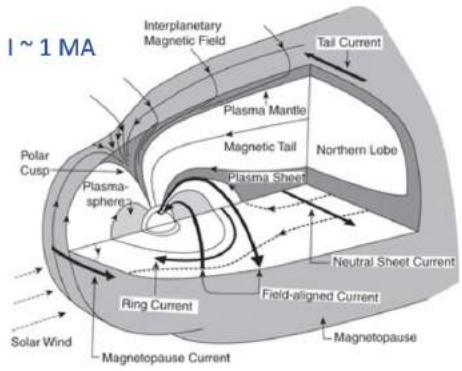

INVESTIGAÇÃO

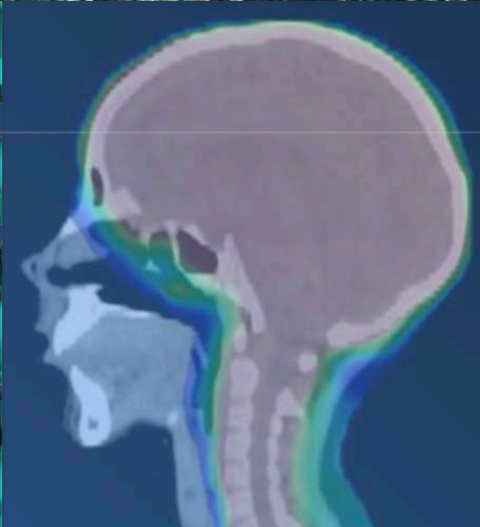
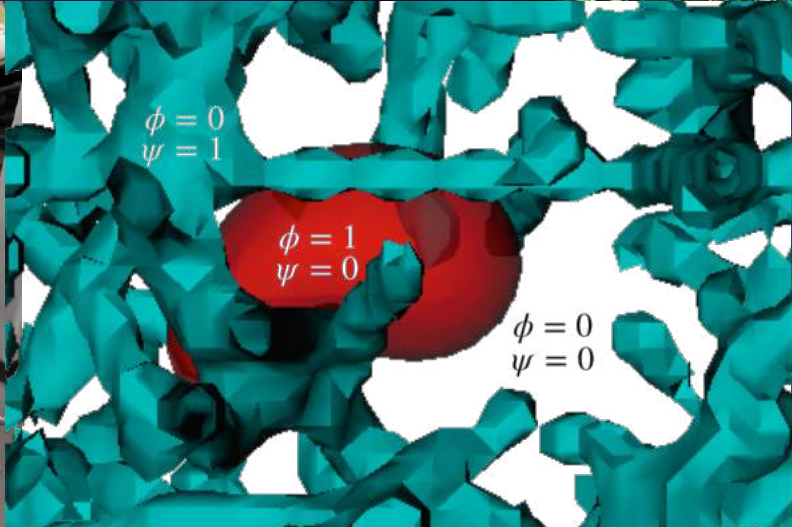
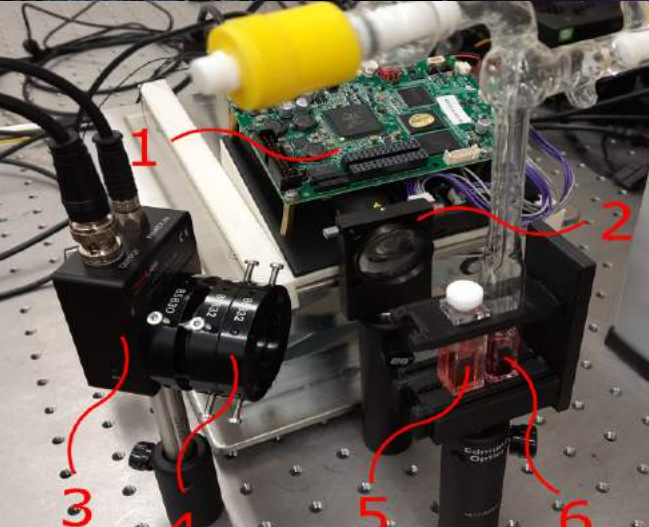

MULTIDISCIPLINARITY 2017-2022



1389 publicações: 34 highly cited, 4 hot papers, 42 reviews, 1054 open access

INTERNATIONALISATION



118 Countries



WORKING GROUPS

WG1: HADRON PHYSICS AND FUNDAMENTAL INTERACTIONS

Hadron phenomenology and QCD, precision QCD, Lattice QCD, interplay between particle and gravitational physics,

WG2: MULTIFUNCTIONAL MATERIALS

Multiferroic, magneto-optical, topological, thermoelectric materials, microwave spectroscopy

WG3: CHEMICAL AND APPLIED CONDENSED MATTER PHYSICS

Multidisciplinary research at the Chemistry/Physics interface, including Engineering applications (X-Ray Diffraction [XRD], Mössbauer)

WG4: SOFT AND BIOLOGICAL MATTER

Biological systems where Physics plays important role (vessel growth, tumour development, cell migration, cytoskeleton dynamics)

WG5: ASTROPHYSICS AND COSMOLOGY

physics of white dwarfs, neutron stars and black holes, radio astronomy, exoplanets, dynamics of stellar and planetary systems, interplay between particle and gravitational physics, dark matter, dark energy, inflation, baryon asymmetry



CFisUC

WHAT IDENTIFIES US?

EXPERTISE IN

- * Muon spectroscopy
- * Neutron scattering and synchrotron radiation
- * X-Ray Diffraction
- * Theory of compact stars
- * Lattice QCD
- * Hadron phenomenology
- * Modelling Vessel Growth
- * Computational Physics ((TD)DFT code development)
- * Exoplanets
- * Dark matter and dark energy, inflation

INTEGRATION OF THEORETICAL, COMPUTATIONAL AND EXPERIMENTAL SKILLS

INTERDISCIPLINARY, MULTIDISCIPLINARY, TRANSDISCIPLINARY RESEARCH

- * Physics/Chemistry/Biology/Engineering/Materials Science/Cultural Heritage/Scientific Computing

Microwaves to reveal detailed structures of molecular motors? Microwave spectroscopy **meets** molecular nanotechnology

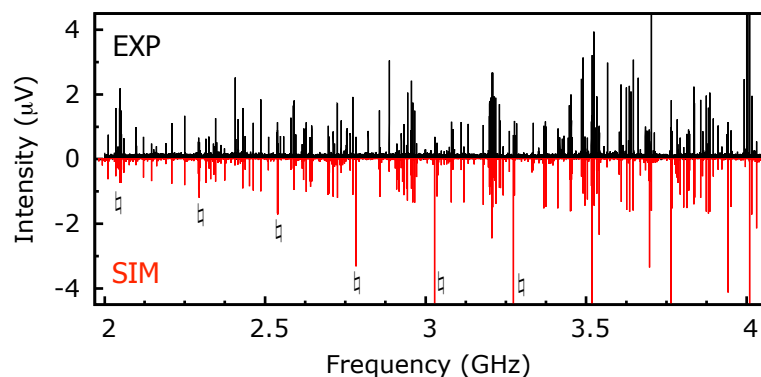
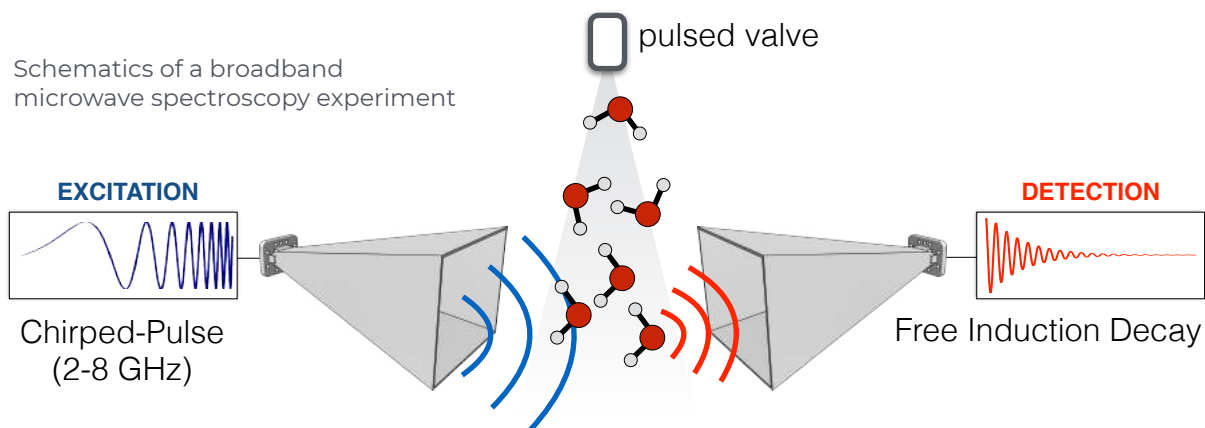

Rotational Constants
(**Experimental**)

A 307.183437(46) MHz

B 164.951398(47) MHz

C 122.506084(33) MHz

Validate Theoretical **3D Structural Models** (Ab initio, DFT)

A new frontier in molecular spectroscopy

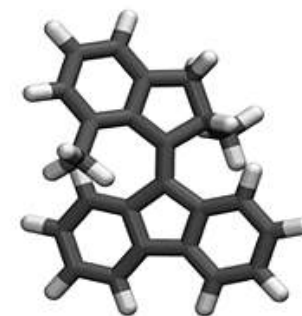

Credit: University of Groningen (RUG)

Developing high resolution microwave spectroscopy into a highly-targeted scientific tool to uncover **structure** and **dynamics** of artificial molecular machinery.

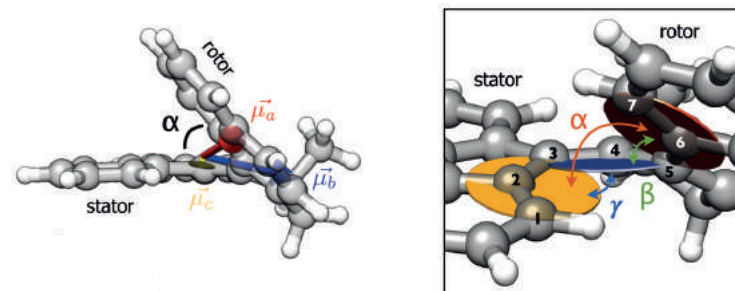

Structure of Artificial Molecular Motor in Idle Mode.

ANGIOGENESIS IN DIABETES

COMPUTATIONAL MODEL FOR VESSEL GROWTH IN 2D AND 3D

- Reference model of angiogenesis simulation
 - Used by several groups in the community
 - Applications to tumour growth and other pathologies
- National and international collaborations

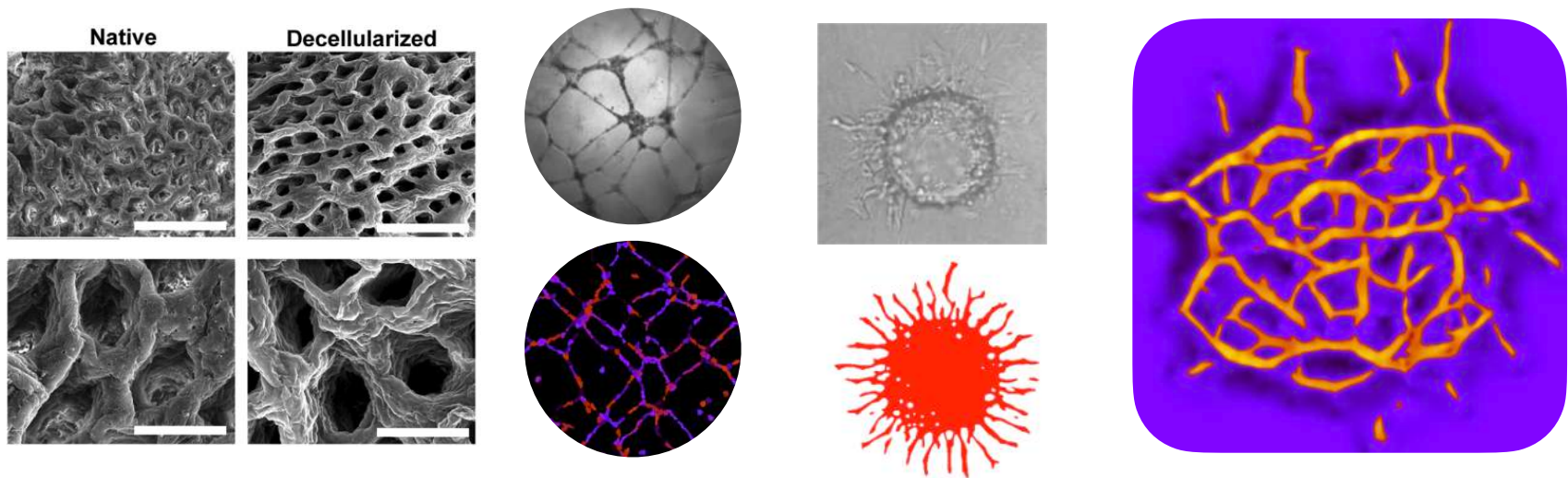

- Mechanical characterisation of decellularized tissues of diabetic mice
 - Role of tissue mechanics in vascular growth in diabetes

LIGHT CLUSTERS IN STELLAR MATTER

We developed a model for warm stellar matter with light clusters:

PRC85 055811 (2012), PRC91 055801 (2015)

Interest on the model:

- Gerd Roepke of the University of Rostock
- Francesca Gulminelli of LPC Caen

Improved model describing the experimental results of Qin et al., PRL108 172701 (2011) proposed in PRC97 045805 (2018), PRC99 055806 (2019)

Analysis of experimental results obtained at GANIL: inclusion of medium effects for the first time
Pais Phys.Rev.Lett. 125 (2020)

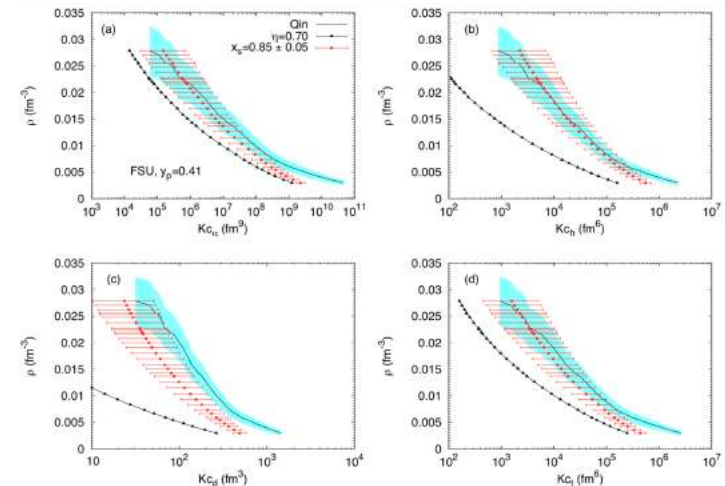

HYDROGEN IMPURITY IN HIGH-K OXIDES

"World leading team in this field of muon studies"

— T. Prokscha

President of the International Society for Muon Spectroscopy (Letter of support, 2017)

Hydrogen in high- κ oxides have been thoroughly investigated in Coimbra by **muonium spectroscopy** and *ab-initio* calculations with very relevant results:

- characterization of novel hydrogen-polaron complex in TiO_2 and ZrO_2 ;
- unique *ab-initio* modelling of hydrogen impurity in *f*-electron system (Lu_2O_3), confirmed experimentally by the muonium analogue;

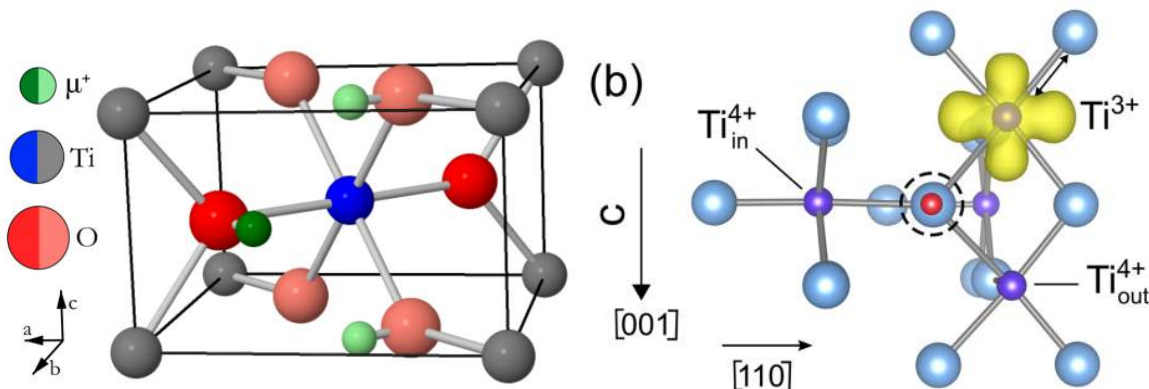

Coimbra's muonium spectroscopy and *ab-initio* calculations triggered further work in

- Infrared spectroscopy (M. Stavola, Lehigh)
- *Ab-initio* calculations (W. Beall Fowler, Lehigh)
- Photoconductivity and infrared (E. Lavrov, Dresden)
- μSR in rutile (R. Kadono, J-Park)
- μSR in anatase and brookite (P. Mengyan, Michigan)

ENAbiling Green E-science for SKA

Capacitation and Sustainability of Portuguese participation in the SKA

ENGAGE
SKA
PORTUGAL

The Square Kilometre Array (SKA) is an intergovernmental radio telescope project being built in Australia and South Africa.

It will operate over a wide range of frequencies and its size will make it 50 times more sensitive than any other radio instrument.

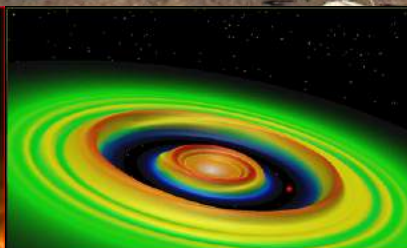
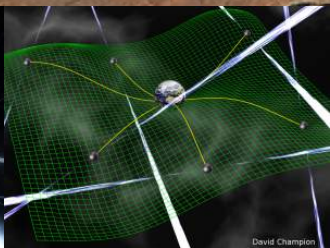

ENAbiling Green E-science for SKA

Capacitation and Sustainability of Portuguese participation in the SKA



CFisUC is the leader of the ENgAGE SKA Working Package "*Scientific Exploration*". The main goal is to develop scientific research on the fields covered by the SKA science and prepare the feasibility of future observations. These include Extra-Galactic Astronomy, Transient and Pulsar observations, Cosmology, Computational Astrophysics, and the *Cradle* of Life (exoplanets).

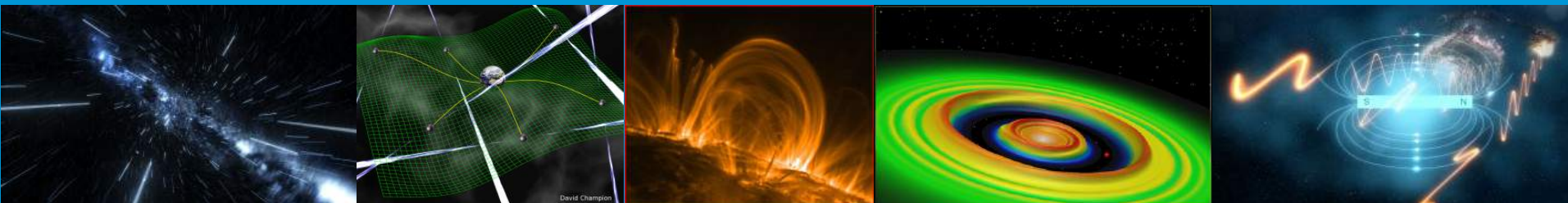



EQUIPMENT & INFRASTRUCTURES

TECHNOLOGICAL PLATFORMS UNDER CFISUC MANAGEMENT

- Navigator Computer Cluster
- Coimbra Trace Analysis and Imaging Laboratory (TAIL-UC): PPMS 1.8- 400 K/ 9T (VSM, Cp, Electrical and Thermal Transport, Torque Magnetometry, High Pressure Cell), AFM/STM, ICP-MS, SEM/EDS, XRF,...

OTHER EQUIPMENT

- Adamastor
- XRD, Mössbauer, Positron Annihilation, Raman, DSC, ...





INTERNATIONALISATION

INTERNATIONAL NETWORKS

- PRACE, ETSF, SKA, EuroHPC

LARGE INTERNATIONAL COLLABORATIVE INFRASTRUCTURES

- PSI, ISIS, ESRF, ILL, FRM2

H2020 PROJECTS AND COST ACTIONS

- Strong 2020 for strong interaction studies
- FIS-NN for fundamental Interactions and Neutron stars
- THOR and PARTICLEFACE for QCD
- PHAROS for neutron stars
- MOLSPIN for Molecular Spintronics
- EuroCellNet for multidisciplinary studies on cellular networks
- G2net for Machine Learning applied to gravitational waves
- TUMIEE for Modeling Intense Electronic Excitations
- EUTOPIA for topology in soft matter
- MW-GAIA for Revealing the Milky Way with Gaia





LIP-COIMBRA

LIP EM COIMBRA, LISBOA E MINHO

- Ligação estreita às universidades
- 200 membros: investigadores, engenheiros, técnicos, administrativos, estudantes de pós-graduação

PÓLO DE COIMBRA

- **Física de partículas e astropartículas**
 - ✓ CERN, matéria escura, neutrinos
- **Detetores de radiação**
 - ✓ Detetores gasosos e de líquidos nobres
- **Aplicações**
 - ✓ Saúde: PET, Orto-CT, terapia com feixes de prótons
 - ✓ Astrofísica e espaço: instrumentação para polarimetria gama
 - ✓ Neutrões: detetores sem ^3He
- 35 investigadores, 15 engenheiros, técnicos e administrativos, 25 estudantes

A black and white photograph of a stone sign for the Department of Physics. The sign is rectangular and has the words 'DEPARTAMENTO DE FÍSICA' engraved in a bold, serif font. The background shows a blurred view of a building with a clock tower, likely the University of Coimbra.



LABORATÓRIO
DE DETETORES
DETETORES
DE RADIAÇÃO
MATÉRIA
ESCURA
NEUTRINOS
SAÚDE
CERN

MUÕES

NEUTRÕES
TÉRMICOS

AUTOMAÇÃO
E CONTROLO
OFICINA DE
PRECISÃO
ESPAÇO



FÍSICA DE PARTÍCULAS E ASTROPARTÍCULAS

EXPERIÊNCIA ATLAS DO LHC (CERN)

- Medidas e fenomenologia do bóson de **Higgs**, quark **top**, procura de **nova física**, física de **jatos** hadrônicos

EXPERIÊNCIAS LUX E LZ (EUA)

- Procura direta de **matéria escura** e **decaimentos raros** do Xénon

EXPERIÊNCIA DUNE (EUA)

- Próxima geração de experiências de **oscilação de neutrinos** – criados por um feixe de prótons no Fermilab, a 1300 km

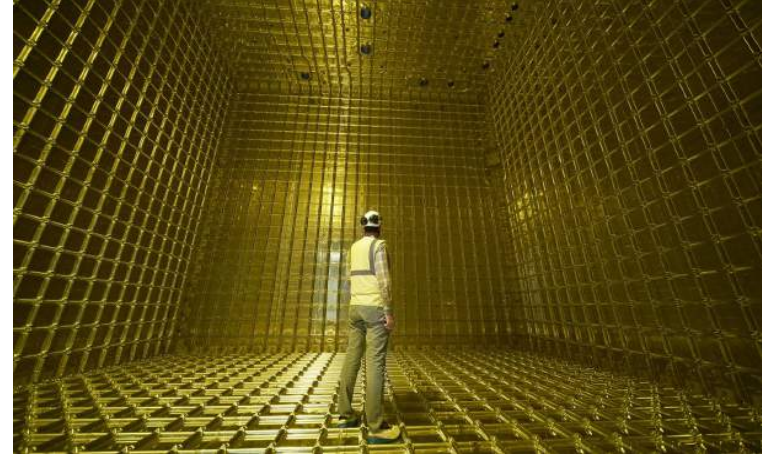
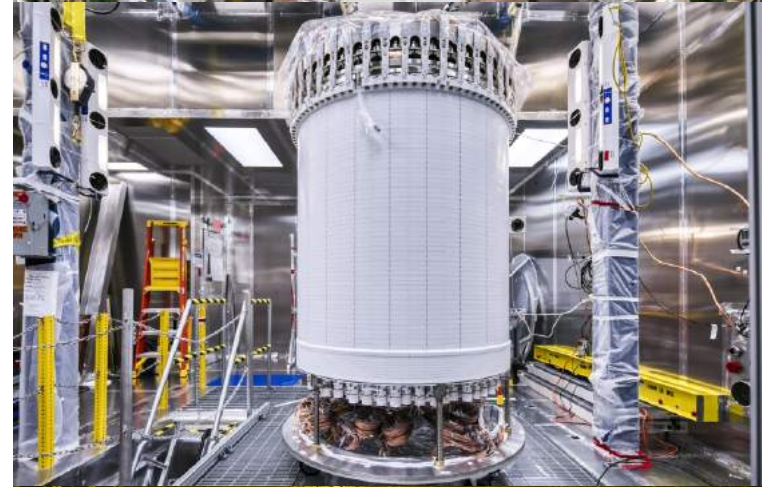
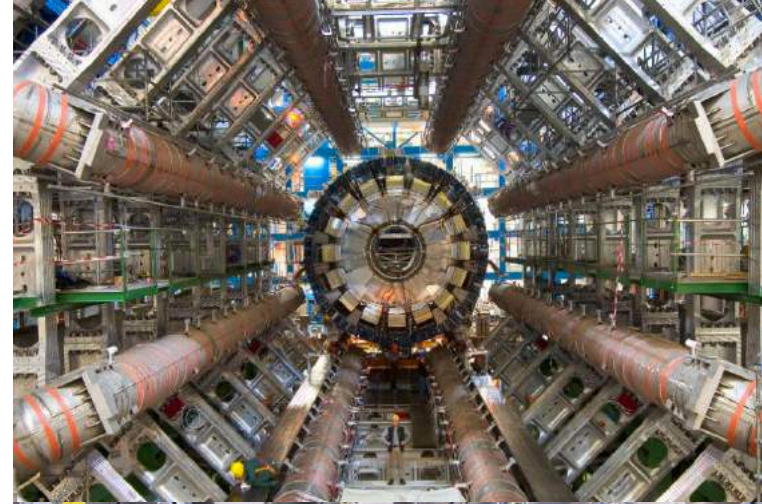



DETETORES DE RADIAÇÃO

RPCs

- Estudo e desenvolvimento destes detetores gasosos intrinsecamente rápidos, flexíveis e robustos
- P/ex. detetor Time of Flight da experiência de física nuclear HADES

DETETORES DE LÍQUIDOS NOBRES

- Diretamente relacionados com experiências de neutrinos e matéria escura em que o LIP colabora

DETETORES GASOSOS

- Estudos de mobilidade de iões e eletrões em gases

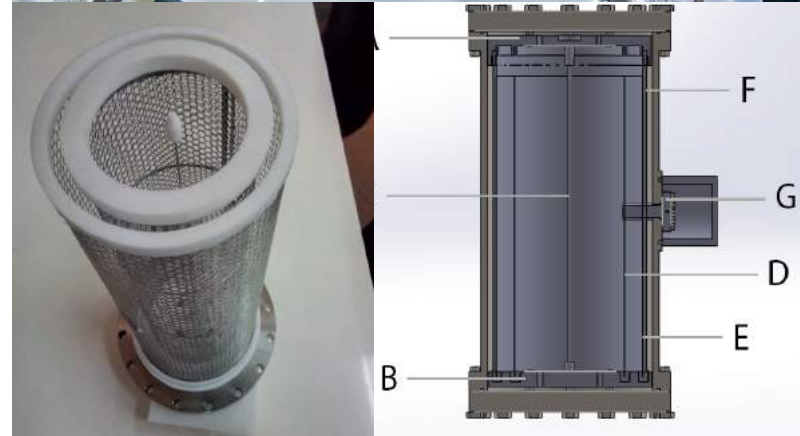
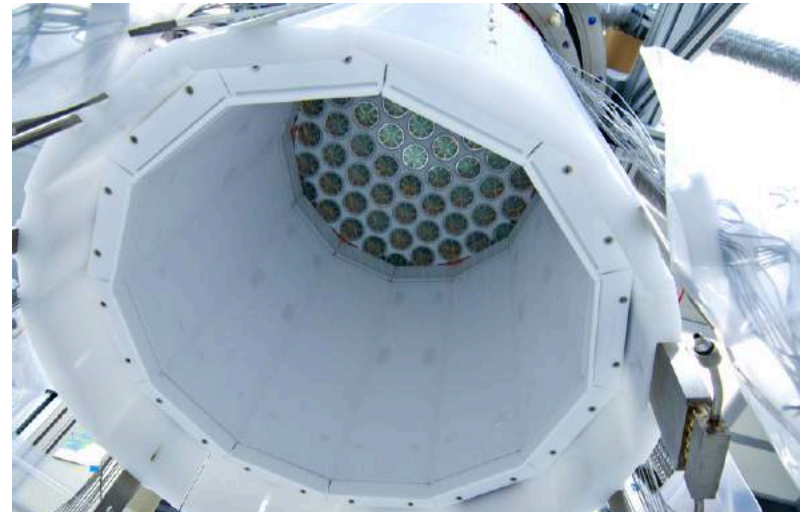
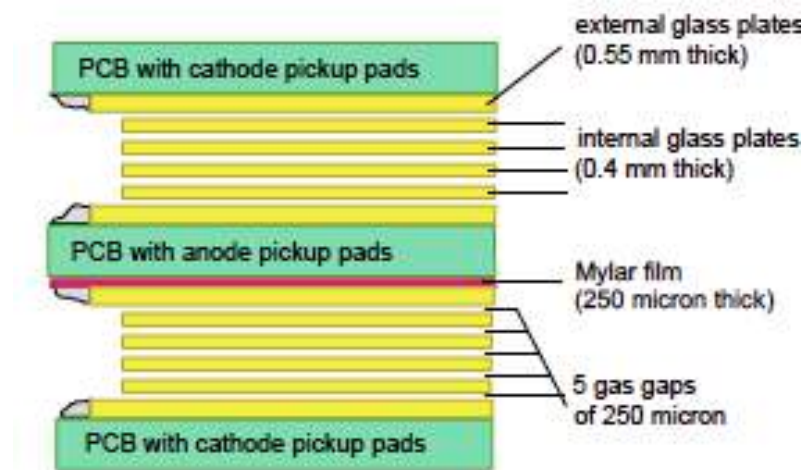



ALGUMAS APLICAÇÕES

Brain-PET

- Protótipo de **tomógrafo PET** para cérebro baseado em detetores RPC neste momento em testes no ICNAS

Instrumentação para **radio- e proto-terapia**

- P/ex. deteção de emissão ortogonal de raios-x para localização precisa da irradiação

Deteção de **neutrões térmicos**

- Detetores RPC revestidos com Boro, evitando uso de ^3He , para European Spallation Source

Tecnologia para o Astrofísica e Espaço

- Instrumentos para **polarimetria de fótons gama**

Sociedade

- Centro de competências em monitorização e controlo
- Instrumentação para muografia geológica
- Deteção de contrabando em contentores
- Respiradores de emergência no início da pandemia
- Etc

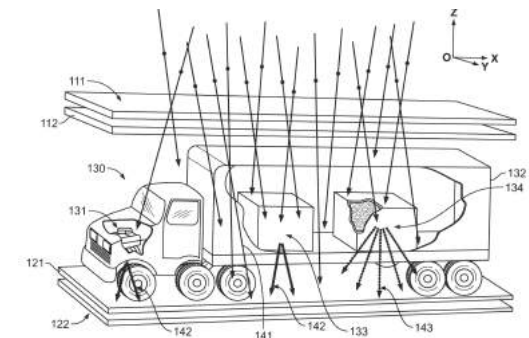
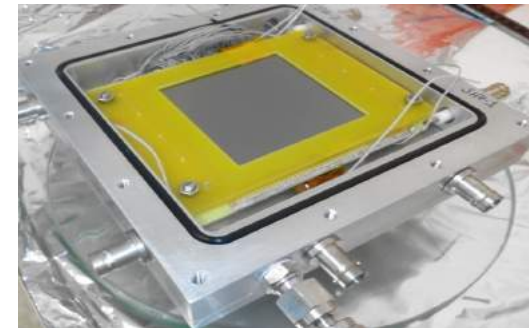
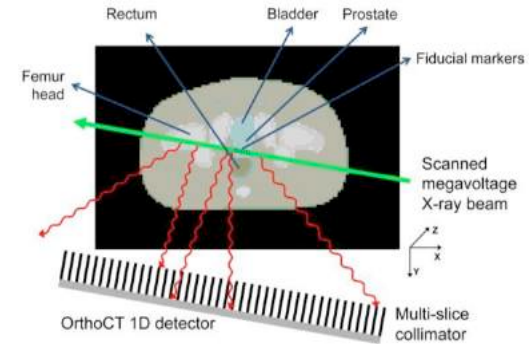
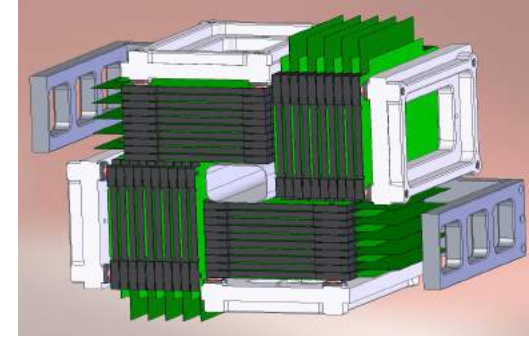

RPC-PET: planeamento de um tomógrafo PET de corpo inteiro?

- Ótima resolução espacial de RPC-PET melhora capacidade de identificação precoce de lesões

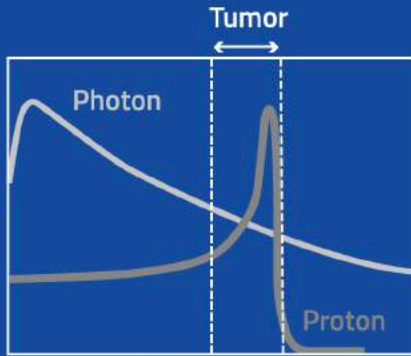
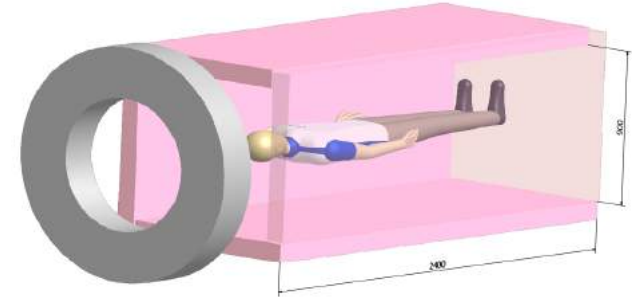

Proton-therapy

Comparison between a photon and a proton beam in what concerns energy deposition as a function of depth (J. Seco, 2019)

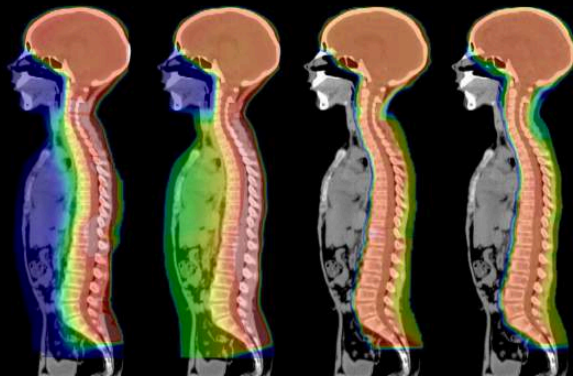
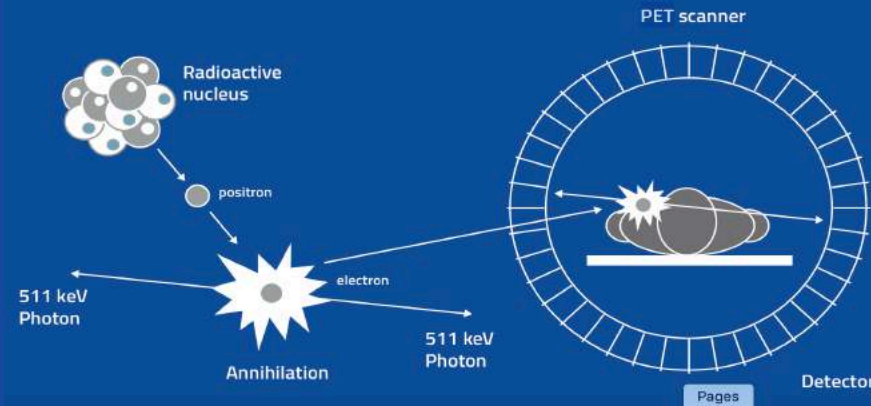

Instrumentação para proto-terapia

- Centro de tratamento com feixes de prótons será instalado em Coimbra (ICNAS) e Lisboa (CTN)
- Deposição localizada de energia (pico de Bragg) limita danos em tecidos sãos



O FUTURO

FÍSICA DE PARTÍCULAS

Nos próximos 5 anos:

UPGRADES DE ATLAS

- Fase de alta luminosidade do LHC: 2026-2040
- LIP responsável por várias áreas do calorímetro, trigger, e novo detetor de alta resolução temporal

EXPERIÊNCIA DUNE

- Próxima geração de experiências de oscilação de neutrinos com linha de base longa (1300 km)
- Demonstrador (proto-DUNE) em testes no CERN
- LIP responsável por vários sistemas de calibração

FCC Futuro Colisionador Circular

- Estudo internacional para o desenho de uma instalação experimental para suceder o LHC
- FCC-ee (colisionador e^+e^-) seguido de FCC-hh (p-p)
- Estudo até 2025; possível início do FCC em 2040
- LIP: estudos de fenomenologia e desenvolvimento de detetores de cintilação resistentes à radiação

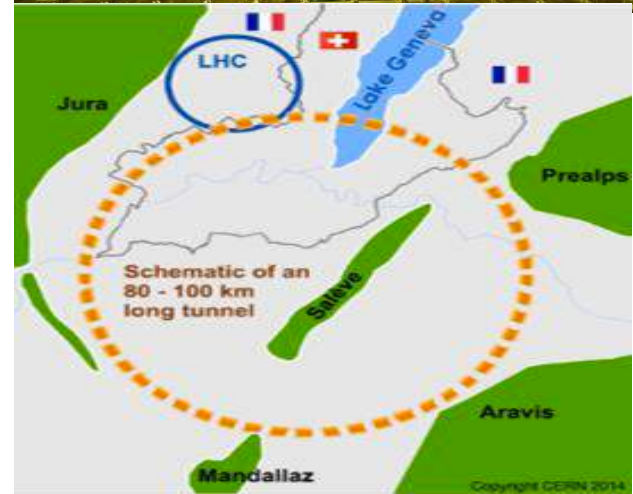
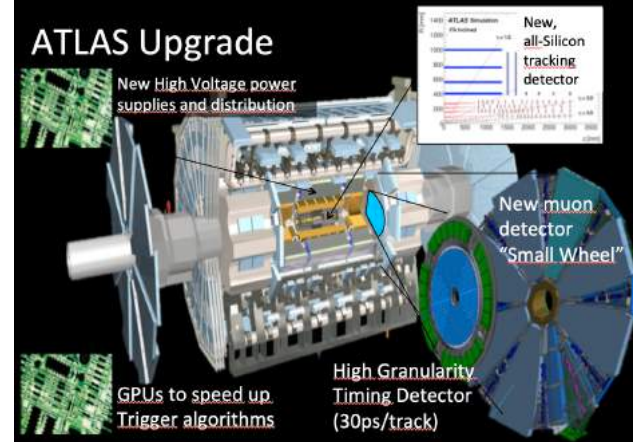

INFRASTRUTURAS DE APOIO

EM COIMBRA



Laboratório de detetores

- Desenho e construção de detetores e eletrónica de aquisição

Centro de competência em monitorização e controlo

- Projetos na física experimental e instrumentação para biologia

Oficina mecânica de precisão

- Desenho e execução mecânica de precisão
- Ideal para protótipos e pequenas séries

Em todos os casos muitas colaborações com UC e exteriores

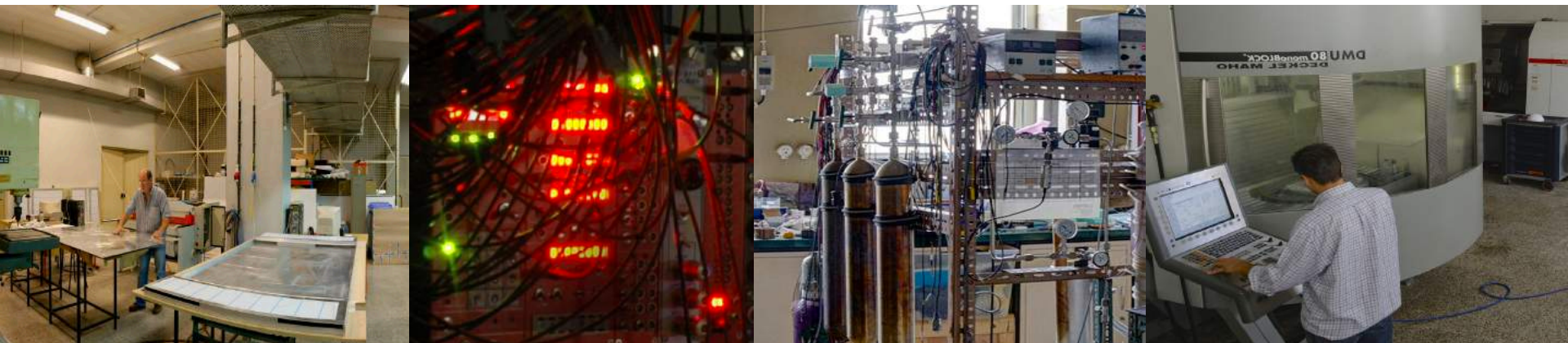



LIBPhys-UC

CREMA

Charge Radius Experiments with Muonic Atoms

- The CREMA collaboration (Switzerland, Germany, France, Portugal and Taiwan), measurement with high accuracy the 2S-2P Lamb-shift in several muonic atoms, Paul Scherrer Institute (PSI), -> **charge nuclei radius were extracted with unprecedented precision.**
- Future: measurement of the 1S hyperfine splitting in muonic hydrogen -> **Zemach radius and the magnetic moment distribution radius of the proton.**
- **CREMA: laser spectroscopy**, the number of golden-events is very low and maximal efficiency of the full-system is needed, from laser technology to x-ray detectors and related instrumentation.

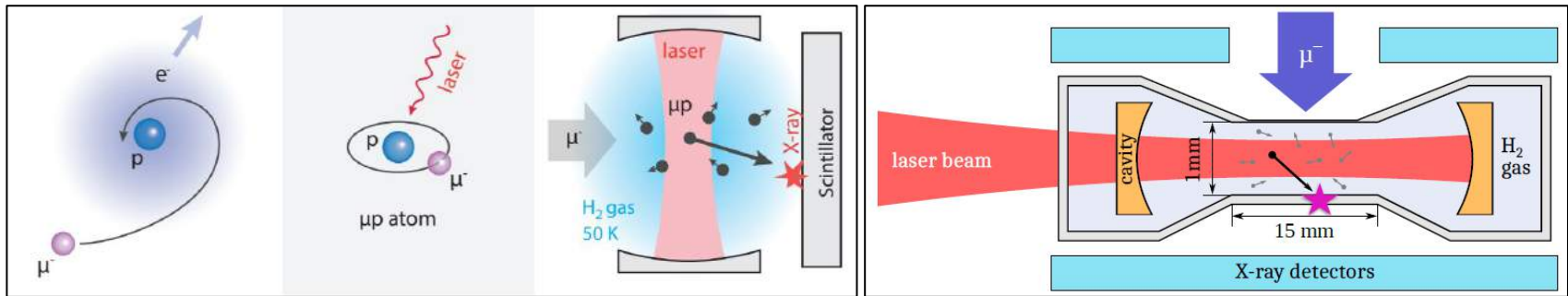

- LIBPhys belongs to the collaboration since its beginning two decades ago. Currently, two teams at LIBPhys-UC (GIAN) and LIBPhys-UNL are involved in the CREMA activities (about 15 people).

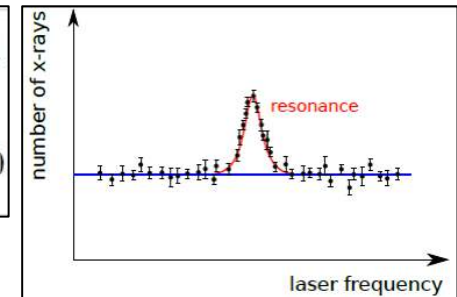
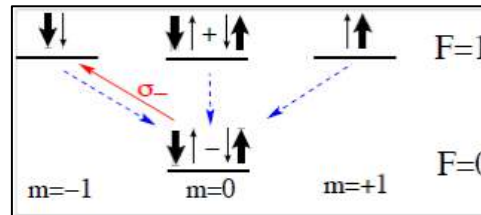

- LIBPhys-UC is co-responsible with PSI for the electron and x-ray detection systems for the HyperMu experiment, R&D activities underway in the last 3 years. LIBPhys-UNL is mostly involved in simulation studies.

@next Neutrino Experiment with a Xenon TPC

The NEXT experiment aims to **demonstrate the Majorana nature of neutrinos** and access their absolute mass by detecting the **neutrinoless double beta decay** in ^{136}Xe .

NEXT uses a **high-pressure Xe electroluminescence Time Projection Chamber (TPC)**, allowing to discriminate background events based on their topology.

A 100-Kg ^{136}Xe detector (**NEXT-100**) is currently under construction at Laboratorio Subterráneo de Canfranc (LSC), after the remarkable success of the **NEW** prototype operating from 2015 to 2021.

LIBPhys has been part of the NEXT collaboration since its beginning, currently with a team of 7 researchers. NEXT comprises 18 institutions from 5 different countries.



NEXT-100

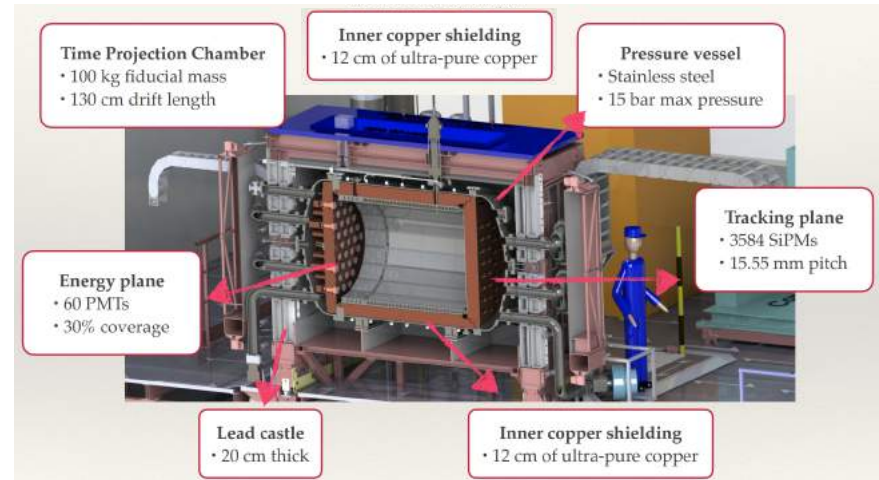

LIBPhys-UC





LIBPhys-UC

XENON



The **XENON** experiment is a collaboration of 160 scientists, representing 24 different nationalities, and 27 institutions across the world.

The main goal of the **XENON** program is the **detection of dark matter in the form of WIMPs** (Weakly Interactive Massive Particles).

LIBPhys-UC participates in the XENON collaboration since it's beginning. 15 researchers have worked in this collaboration, since 2005. The current team is made of 5 researchers.



LIBPhys-UC

XENON10



XENON100



XENON1T



XENONnT

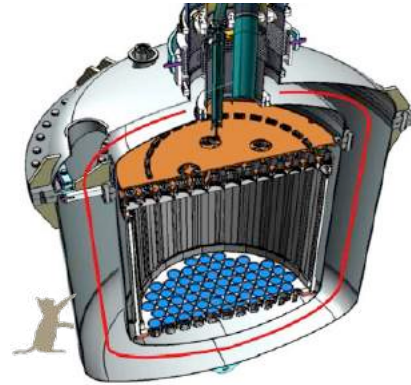

Era	2005-2007	2008-2016	2012-2018	2019-2023
Mass	25 kg	161 kg	3200 kg	~8000 kg
Drift	15 cm	30 cm	100 cm	144 cm
Status	Achieved (2007)	Achieved (2016)	Projected (2018)	Projected (2023)
σ_{SI} Limit (@50 GeV/c ²)	$8.8 \times 10^{-44} \text{ cm}^2$	$1.1 \times 10^{-45} \text{ cm}^2$	$1.6 \times 10^{-47} \text{ cm}^2$	$1.6 \times 10^{-48} \text{ cm}^2$

In 2005 the first science prototype (**XENON10**, with circa 12 kg of Xe) installed underground below 1300m of rock in the Gran Sasso National Laboratory, in Italy.

In 2008 a new prototype, **XENON100**

in 2016 **XENON1T**: 200 lower background radiation level than XENON100, puts XENON in the forefront of the dark matter search world race

In 2018 begins construction **XENONnT**, 8 tons of ultrapure Xe, XENONnT represents the state of the art in the field with the best prospects ever in history for the discovery of the elusive dark matter.



LIBPhys-UC

CYGNO

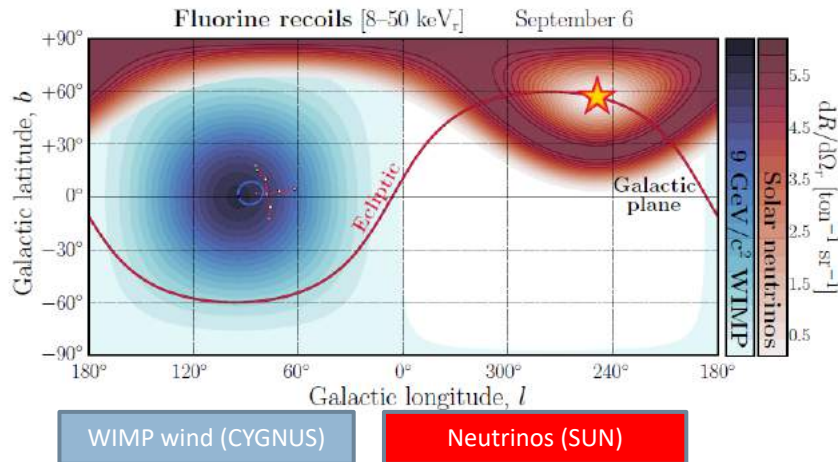
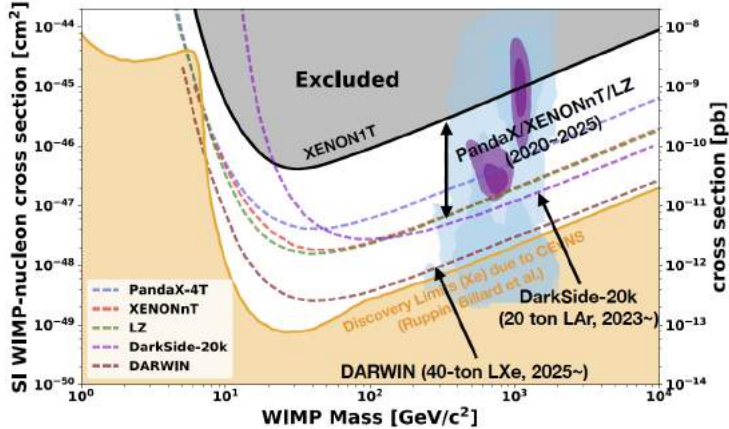

The search for Weakly Interacting Massive Particles (WIMPs) is one of modern physics most challenging experiments.

directional gaseous TPC, which record the recoil energies, the track direction, orientation and dE/dx topology of the recoils, have the potential to remove all backgrounds and prove the galactic origin of an excess over background.

This is the purpose of **CYGNUS**, an **Earth distributed network of gaseous TPC's** with a combined ton scale, which will provide means to deal with seasonal or location dependent backgrounds.

CYGNO, part of the wider CYGNUS, will operate a **high-resolution optical Time Projection Chamber (TPC)** for directional dark matter searches and solar neutrino spectroscopy.

A team of 5 researchers from LIBPhys-UC participates in the CYGNO collaboration.

Single-Pixel Compressive Sensing Imaging of Biomarker Phosphorescence Lifetime

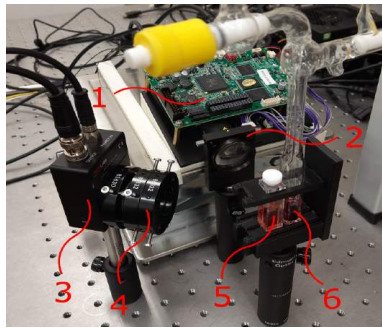

Single-Pixel camera

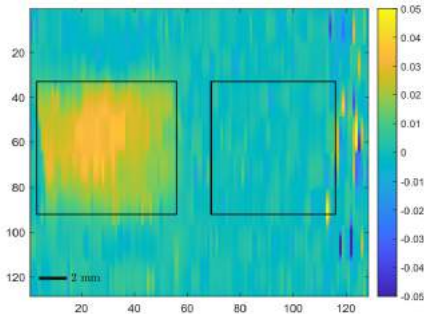

Lifetime Imaging

Multi-dimensional multiscale entropy measures: application to dermoscopic images and CT scans

Entropy as screening tool for large Biomedical images and datasets



Dermoscopic images

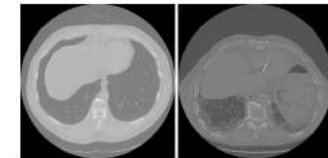

CT scans

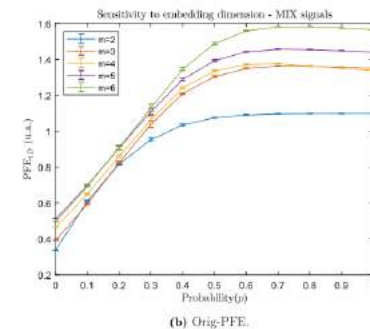
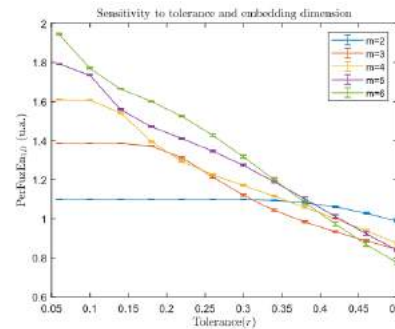

Multi-scale entropy assessment



LIBPhys-UC

PHYSICAL ENGINEERING RESEARCH HIGHLIGHTS

Space Weather - Remote sensing of Geomagnetically Induced Currents with CITEUC collaboration

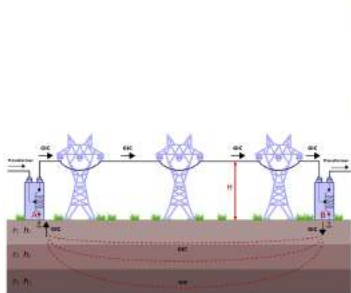

Security and Process Monitoring Approaches for Large-Scale Industrial Automation & Control Systems with DEI collaboration



Supervisory, control and data acquisition (SCADA) security at the PLC ground floor. Industrial Paradigm to Physics Experiments

Laboratory for Instrumentation, Biomedical Engineering and Radiation Physics

Remote Sensing GICs @Paraimo HV Power Station

Projeto MAG-GIC

Correntes induzidas pelo campo geomagnético no território português

GICs (Geomagnetically Induced Currents)

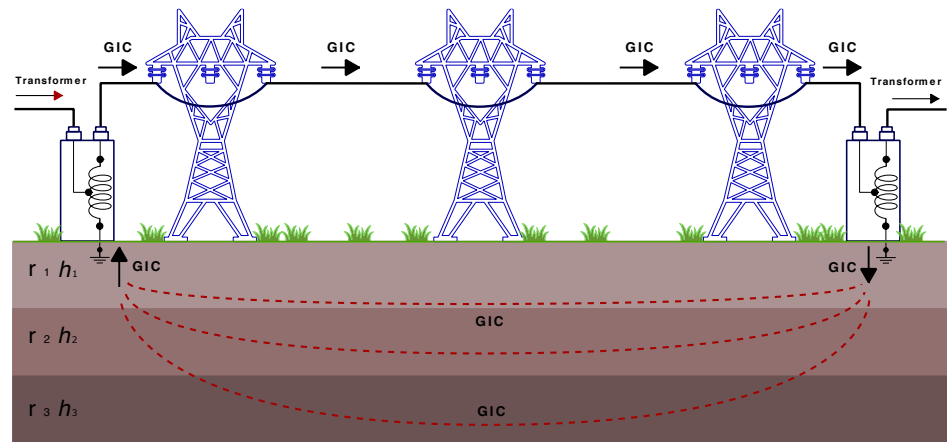
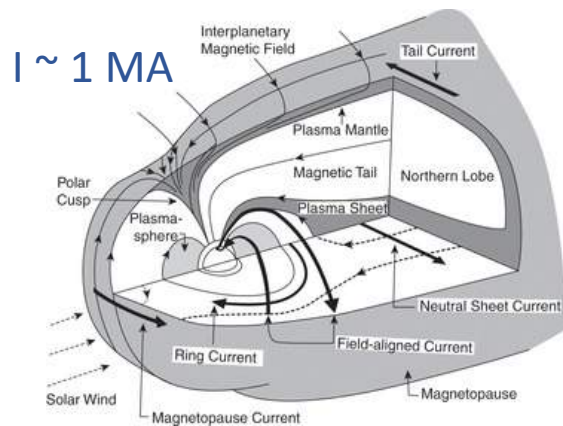

GICs e seus efeitos

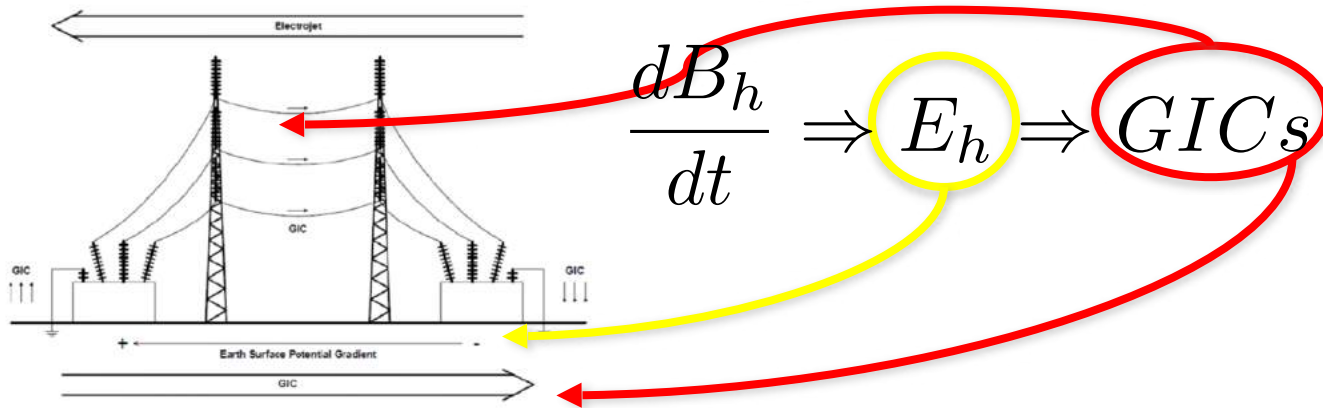

- GICs são correntes DC ($f \sim 0,1 \text{ mHz} - 0,1 \text{ Hz}$)
- Saturam os núcleos de transformadores
- Produzem sobre-aquecimento, harmónicos na rede, vibração mecânica
- Perda de potência reativa nos transformadores
- Fugas de fluxo para fora do núcleo
- Destruição do óleo de isolamento

Observatório magnético de Coimbra (COI)



Observatório
Geofísico e Astronômico
da Universidade de Coimbra

1 2 9 0



FACULDADE DE
CIÊNCIAS E TECNOLOGIA
UNIVERSIDADE DE
COIMBRA

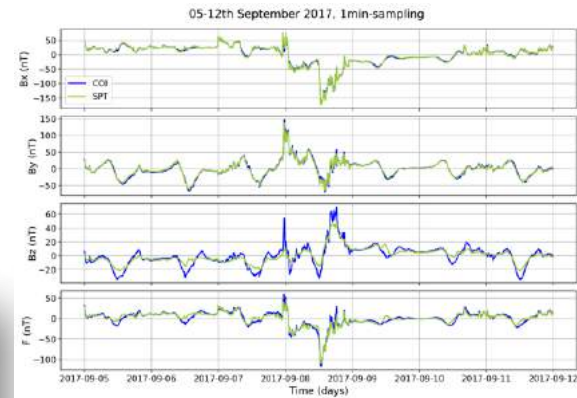

$B \sim 45 \mu\text{T}$
 $\Delta B \sim B/400$



A cidade 'cercou' o observatório

MODELOS VS MEDIDAS

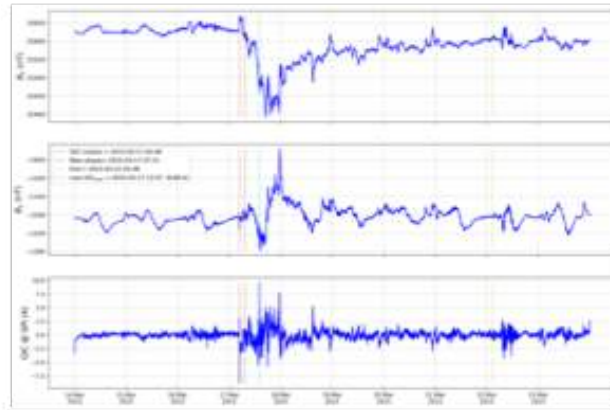
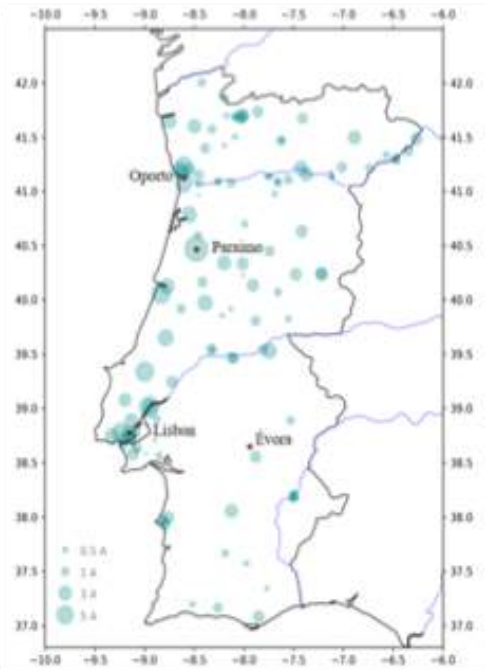

GIC computations
for St. Patrick
Storm (March 2015)

Installation of the GIC
measuring system

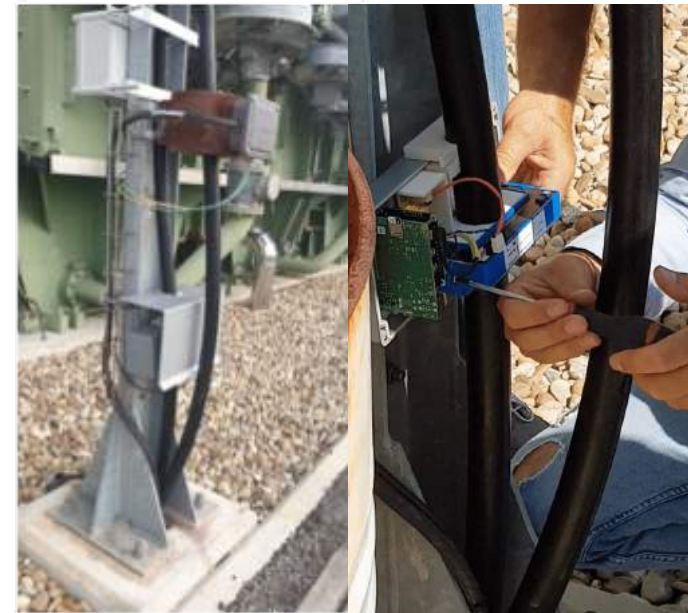

REDE/CONSÓRCIO GEOPLANET

O que é ? A rede GeoPlaNet nasceu em 2016 por iniciativa do Laboratoire de Planétologie et de Géodynamique da Universidade de Nantes ([LPGNantes](#)), tendo como objetivo principal a **promoção e formação na área das Geociências Planetárias na Europa**.

Quem está ? A rede integra uma **vintena de instituições em 16 países**. A participação da [UC/CITEUC](#) está alinhada com as dos demais parceiros, e consiste na interação e colaboração entre investigadores na promoção das Geociências Planetárias na Europa.



PRESENTE E FUTURO DF

Física Solar – Projectos e colaborações



EST

Envolvimento profundo na adesão do Portugal ao projeto/ co-PI de um dos instrumentos planeados



WaLSA

Um membro associado

OUTRAS ATIVIDADES

- Campanhas de observação (2020,2021), em processo de seleção competitivo no SST no valor de 30k euros
- Membro da equipa principal do grupo de desenvolvimento do novo código de inversão em condições de não equilíbrio termo hidrodinâmico local DeSIRe
- Organizadores e formadores, em parceria com o NSO, IAC e IAA, do workshop internacional em ferramentas de síntese e inversão de dados espectro polarimétricos
- Organização com a Universidade de Göttingen do primeiro workshop sobre os dados da Parker Solar Probe em Portugal: dar a conhecer à comunidade científica os dados fornecidos pelo satélite e estabelecer colaborações.
- Membro da equipa do projecto PRIME (Portuguese Regional Ionosphere ModEl)

PRESENTE E FUTURO DF

Física Solar – Projectos e colaborações



solar orbiter

Solar Orbiter / PHI

Scientific team member



SUNRISE III

Scientific team member|
Colaboração no
desenvolvimento nos
instrumentos TuMAG



DKIST

Developer da
infraestrutura de inversões
dos dados nível 2



OREO

Investigador principal do
projeto de atualização do
futuro espectro-polarímetro
do OGAUC

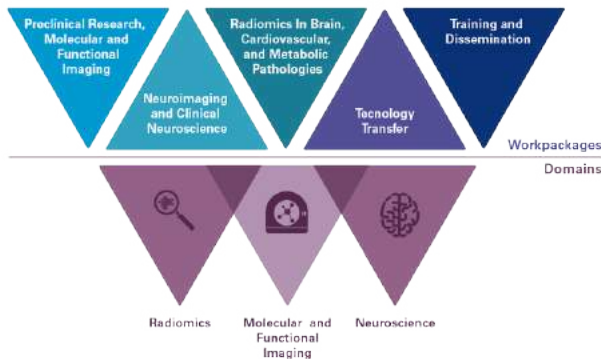

CIBIT: unidade líder em imagiologia biomédica multimodal. Sediada no ICNAS – Instituto de Ciências Nucleares Aplicadas à Saúde.

Avaliação FCT: Excelente.

Foco: **imagiologia biomédica, Investigação translacional.**

Desenvolvimento de biomarcadores de imagem molecular e funcional para Neurociências, Cardiologia e Oncologia.

Imagiologia RM, PET e OCT clínica e pré-clínica.

Neurofisiologia.

Desenvolvimento de sondas moleculares.

Scanners RM Siemens PRISMA 3 Tesla (humanos) e Bruker 9.4 T (animal)

Scanner PET/CT Siemens BIOGRAPH mCT

Scanner PET animal

Dois ciclotrões: IBA 18/9 MeV e IBA Kiube

EEG de alta densidade

Estimulação magnética transcraniana

Imagiologia NIR funcional

Interfaces cérebro-máquina de 64 canais

Imagiologia de bioluminescência/fluorescência

Tomógrafos de Coerência Óptica (OCT): Zeiss Cirrus SD-OCT 5000 (humanos) e Micron IV OCT System (animal)

elastoOCT

Optical Coherence Elastography for imaging retina mechanical properties

PTDC/EMD-EMD/32162/2017



neuroOCE

In vivo retinal optical coherence elastography for early neurodegeneration detection

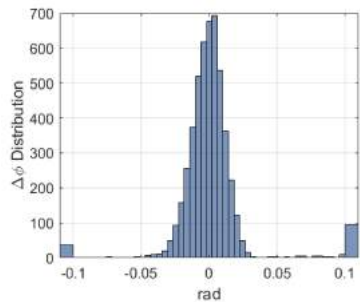
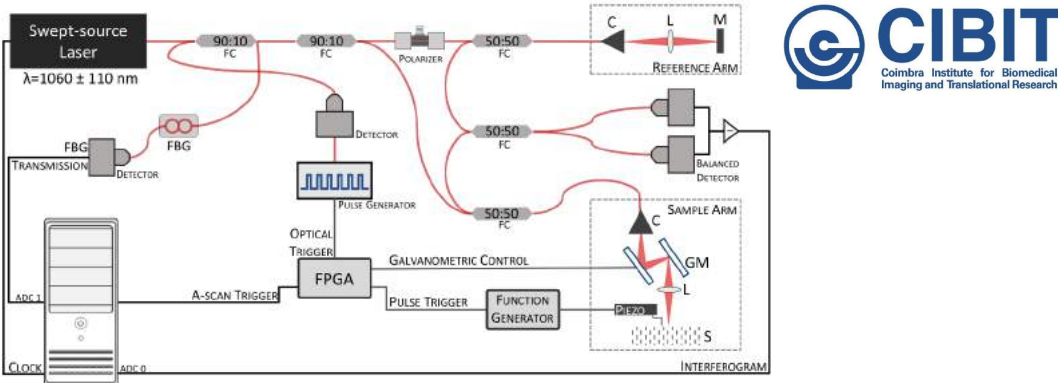

Distribuição de diferenças de fase em condições estáticas: Deslocamento mínimo detectável: 6 nm

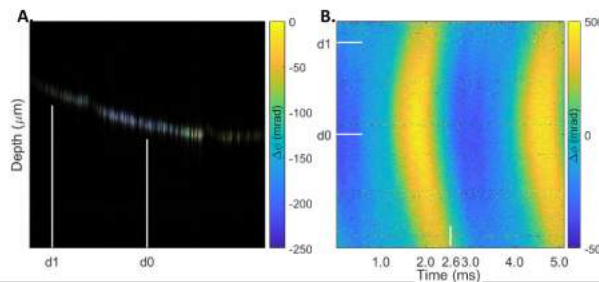

Diferenças de fase ($\Delta\phi$) num fantoma excitado com um impulso de 200 μ s. B-scan estrutural e *overlay* $\Delta\phi$ para $t = 2.56$ ms (A), $\Delta\phi$ ao longo do tempo (B)

Necessidade premente de detectar neurodegeneração na fase assintomática

Modalidades tradicionais de imagiologia cerebral não têm sensibilidade suficiente para tal.

A retina é a única parte do sistema nervoso central que pode ser analisada por técnicas ópticas.

Estudos realizados no CIBIT mostram que os dados OCT podem discriminar entre várias condições de neurodegeneração, na ausência de alterações estruturais. Comprovado em modelos animais de Alzheimer e em humanos.

As propriedades mecânicas dos tecidos biológicos variam muito mais do que a secção eficaz de dispersão óptica: a Elastografia de Coerência Óptica (OCE) deverá ser muito mais sensível que a OCT.

Detectar neurodegeneração fazendo palpação com luz

IMAGIOLOGIA MULTIFOTÃO DA CÓRNEA

Colaboração com o Departamento de Biofotónica e Tecnologia Laser da Universidade de Saarland (Prof. Karsten König)

IMAGIOLOGIA METABÓLICA

MICROSCÓPIA DE TEMPO DE VIDA DE FLUORESCÊNCIA COM EXCITAÇÃO POR DOIS FOTÕES

Avaliação do metabolismo celular sem agentes de contraste exógenos

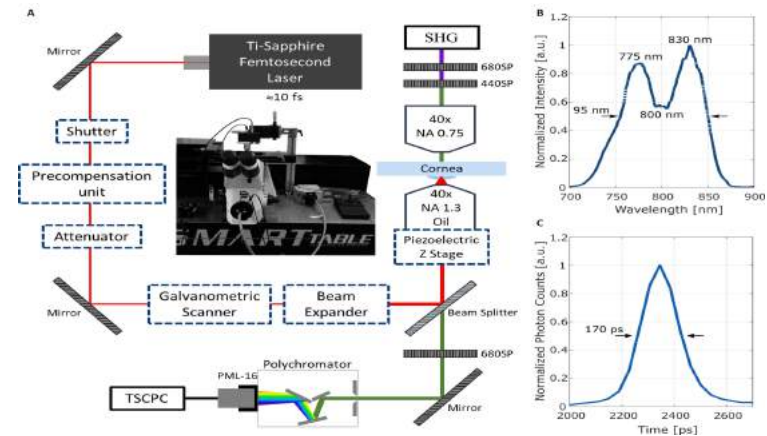

ORGANIZAÇÃO ESTRUTURAL DAS FIBRAS DE COLAGÉNEO

Microscopia por Geração de Segundo Harmónico (SHG)

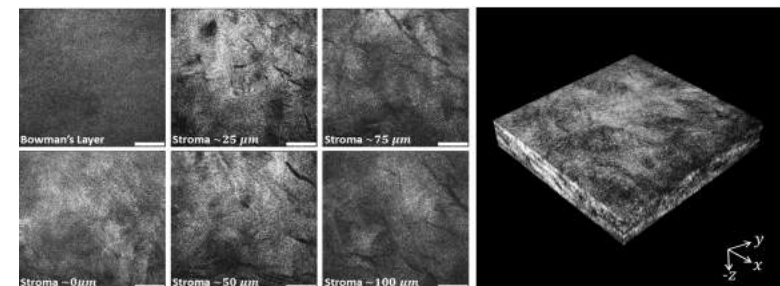
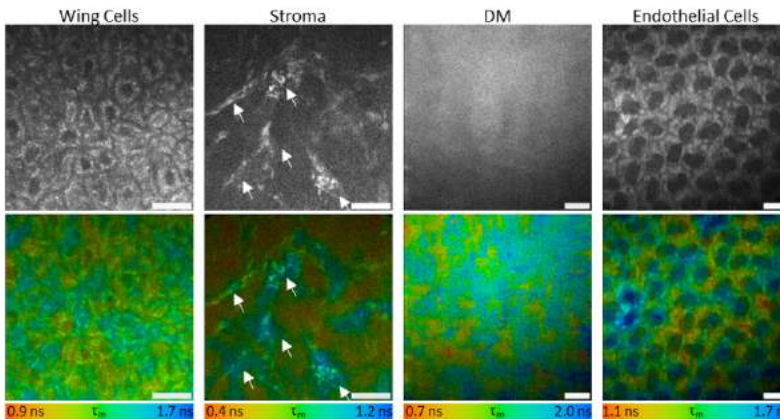

PROJECTO FUTURO

FemtoXL - Cirurgia de queratocone (crosslinking) com laser de femtosegundos

formatação personalizada por óptica adaptativa; avaliação simultânea da eficácia da cirurgia por imagiologia multifotão.

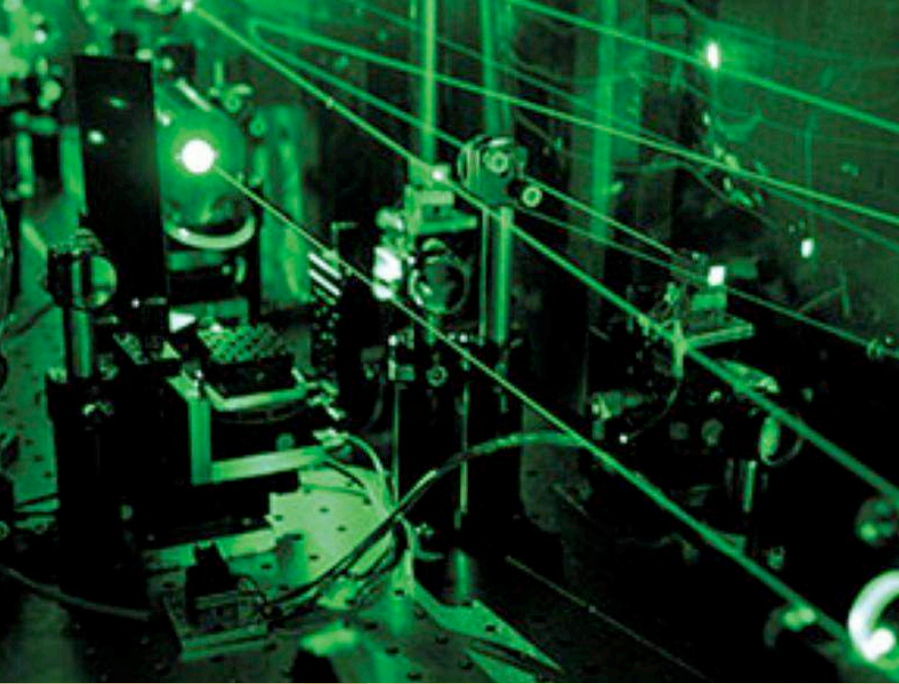

ENSINO



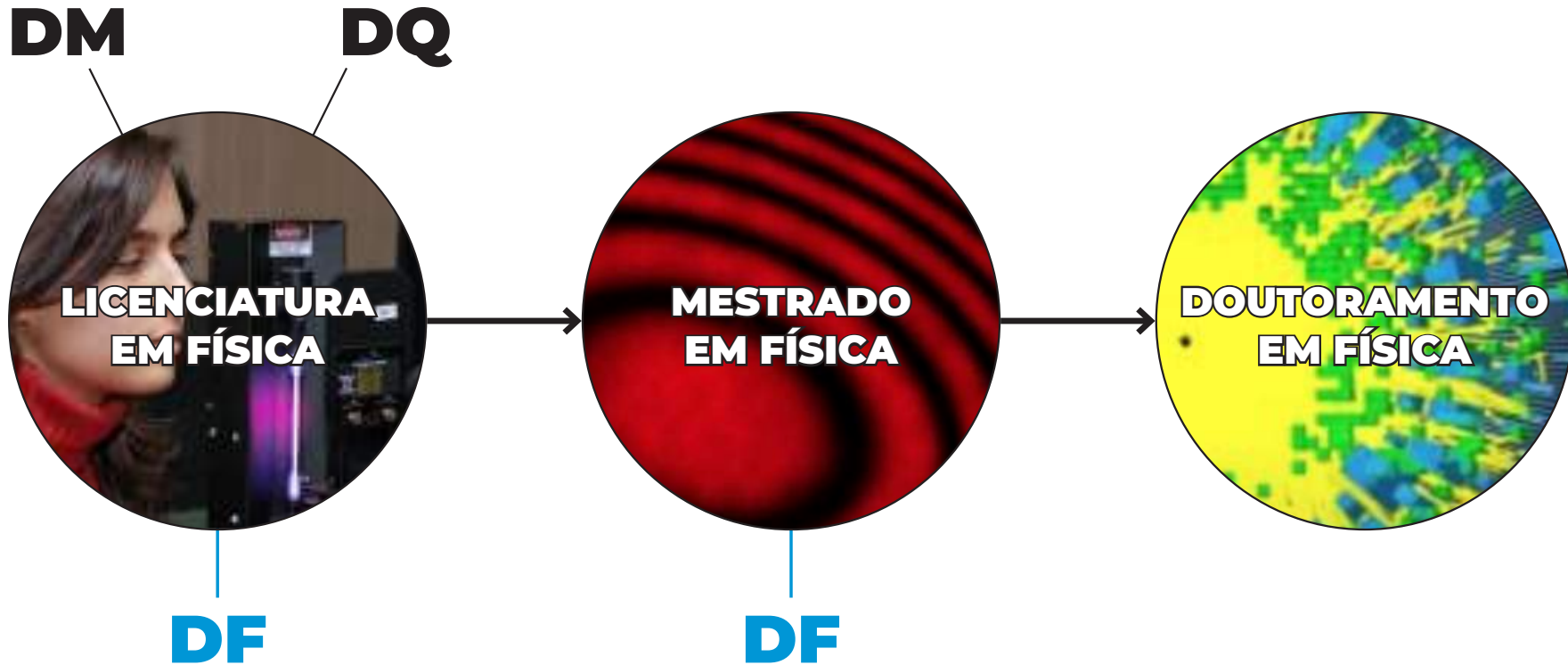

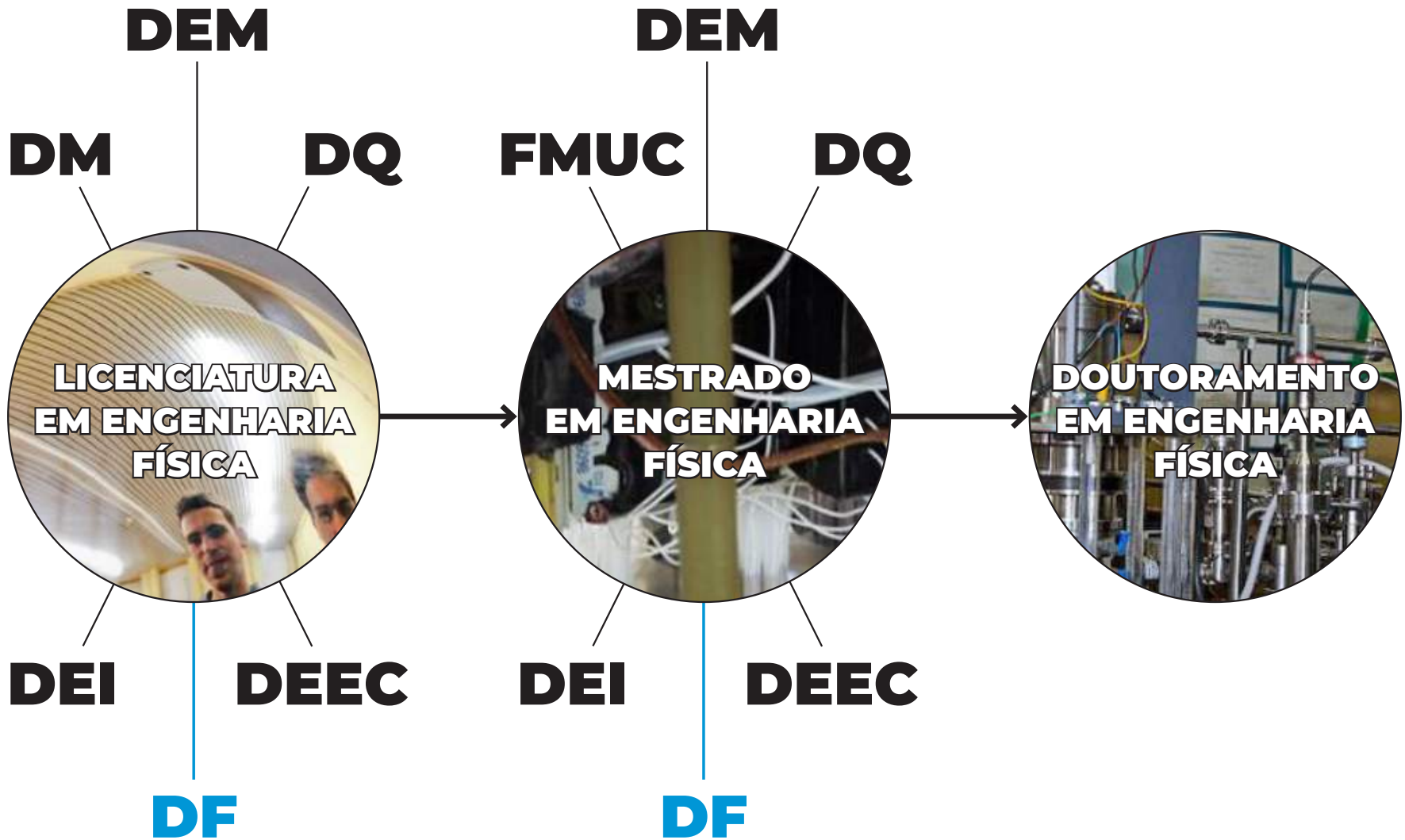

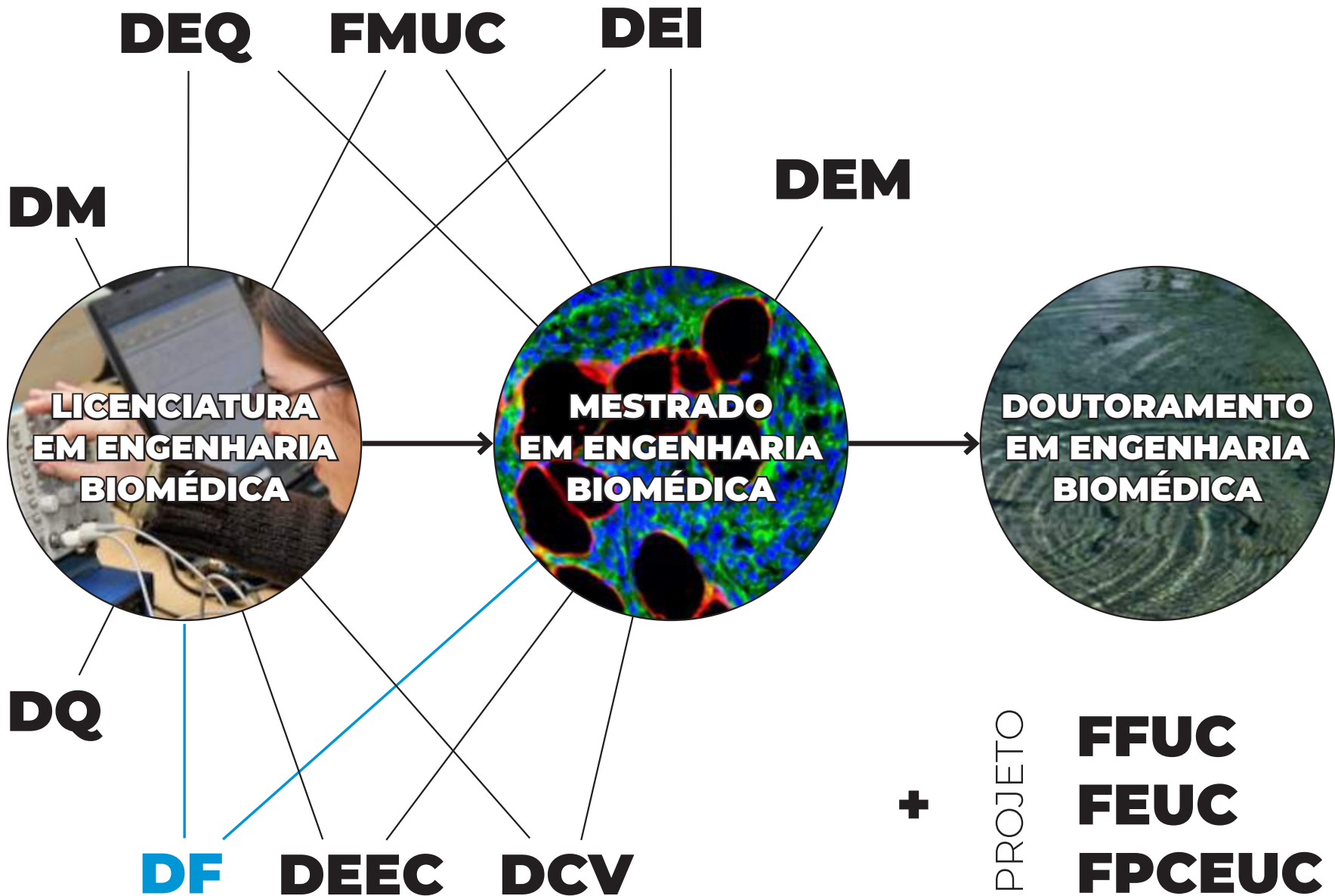

DM

DF

DQ

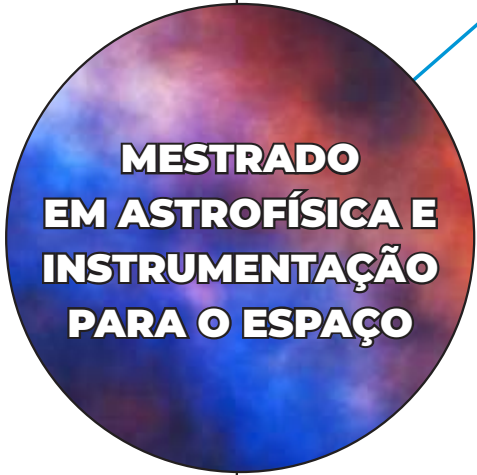

OGA

FMUC

CHUC

IPO

ICNAS

DCV

FPCE

OUTROS CURSOS

COM COLABORAÇÃO DF

Mestrado em Biologia Computacional

Mestrado em Património Cultural e Museologia

Doutoramento em História das Ciências e Educação Científica

Licenciatura em Tecnologias Espaciais de Observação da Terra

Licenciatura em Gestão das Cidades Sustentáveis e Inteligentes

INOVAÇÃO NO ENSINO

Estágios de verão em UI&D e empresas

Integração nas UI&D através da oferta regular de bolsas BII e BI

Integração no DF de juniores empresas e juniores iniciativas

Estímulo à participação no programa Erasmus



ESTUDANTES

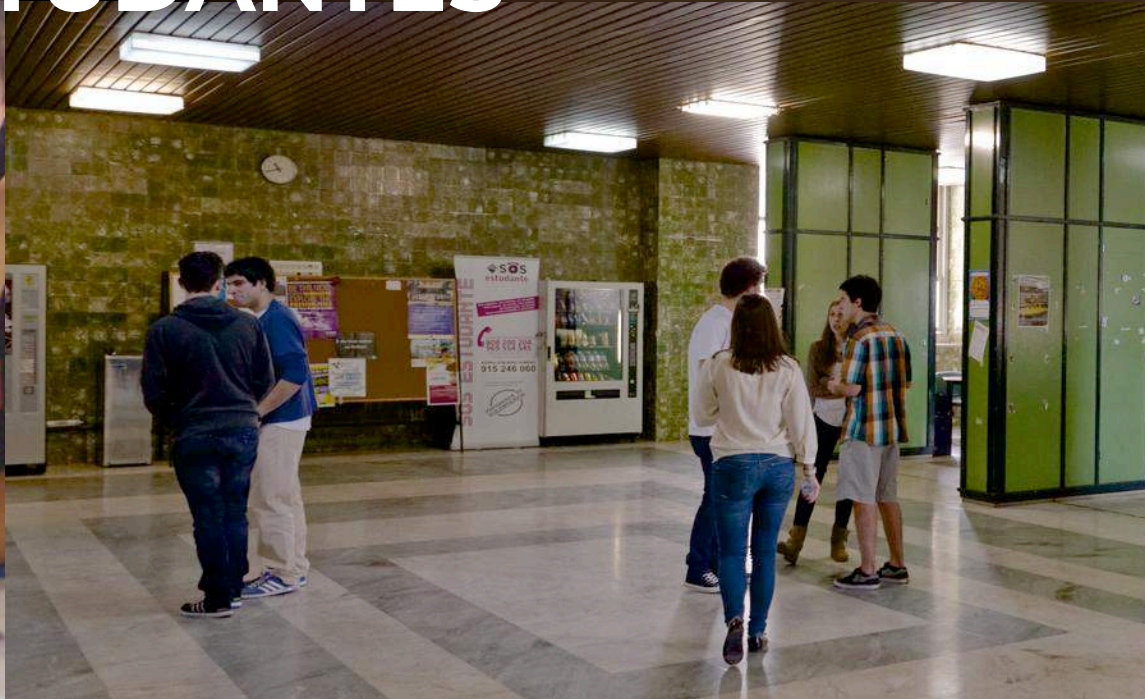

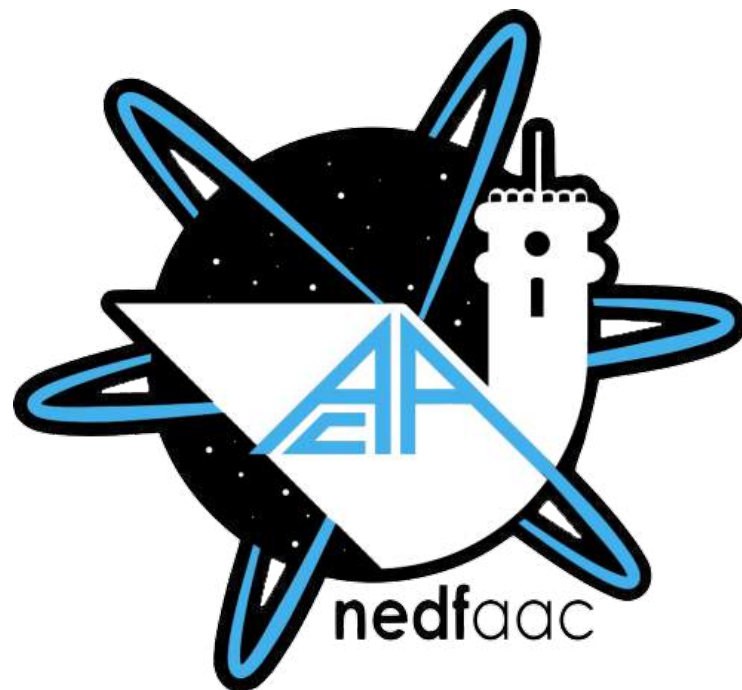

**NÚCLEO DE ESTUDANTES DO
DEPARTAMENTO DE FÍSICA**
DA ASSOCIAÇÃO ACADÉMICA DE COIMBRA

O NEDF/AAC

Fundado a
19 de março
de 1997

Representa
cerca de 800
alunos

Zelar pelos
Interesses dos
estudantes

Proporcionar
diversas
atividades

PARCERIAS



1 2 9 0



FACULDADE DE
CIÊNCIAS E TECNOLOGIA
UNIVERSIDADE DE
COIMBRA



ANEEB
Associação Nacional de Estudantes
de Engenharia Biomédica

PhySIS



jeKnowledge
nurturing excellence



SAÍDAS PROFISSIONAIS



PEDAGOGIA E GAPE



RECREATIVO



RELAÇÕES EXTERNAS



COMUNICAÇÃO E IMAGEM



INTERVENÇÃO CÍVICA





PRÓXIMOS EVENTOS...





DESDE 1991

Associação Portuguesa de Estudantes de Física

Representa todos os estudantes de Física e de Engenharia Física, e de outros cursos diretamente relacionados com a Física do Ensino Superior português, operando a nível nacional.



DESDE 2008

Junior Empresa

Tem o objetivo de proporcionar aos alunos da FCTUC a oportunidade de aplicar os seus conhecimentos académicos em projetos internos e externos, aprendendo novas competências e praticando com situações da vida real.



Junior Empresa

Enraizada na FCTUC. Nasceu do interesse em aprender trabalhando e da vontade de o fazer. Com uma equipa multidisciplinar com especialistas e entusiastas em diversas áreas, desde a programação ao design gráfico.



DESDE 2021

Associação de estudantes de tecnologias do espaço

Iniciativa que simplifica e apoia a relação entre a indústria espacial e os estudantes. Pretendendo preparar os seus membros para a sua carreira profissional, colocando o seu esforço e aplicando competências em projetos.

E AINDA...

BEST

Board of European Students of Technology

Coro Misto da UC

Amnistia Internacional

...



SOCIEDADE



TRANSFERÊNCIA

PHYSICS EDUCATION AND SCIENCE OUTREACH

- * Promotion of physics and excellence in science education
- * "Quark!"-school for talented high-school students
- * Strong collaboration with SPF
- * Coordination of the Physics Olympiads (national & IPhO, OIbF)
- * Outreach activities: projeto Big Bang
- * Centre “Ciência Viva Rómulo de Carvalho”
- * Physics text-books for middle- and high-school scholars



TRANSFERÊNCIA

PHYSICS IN WORLD HERITAGE

- * History of Science in Coimbra (World Heritage Site, EPS historic site)
- * Rehabilitation of historical scientific instruments and sites

PHYSICS FOR INDUSTRY

- * Analytical services, quality control, R&D for Pharmaceutical, Chemical and Electromechanical industries
- * R&D: co-crystals for drug delivery, hybrid compounds for OLEDs, hydrogen storage technology

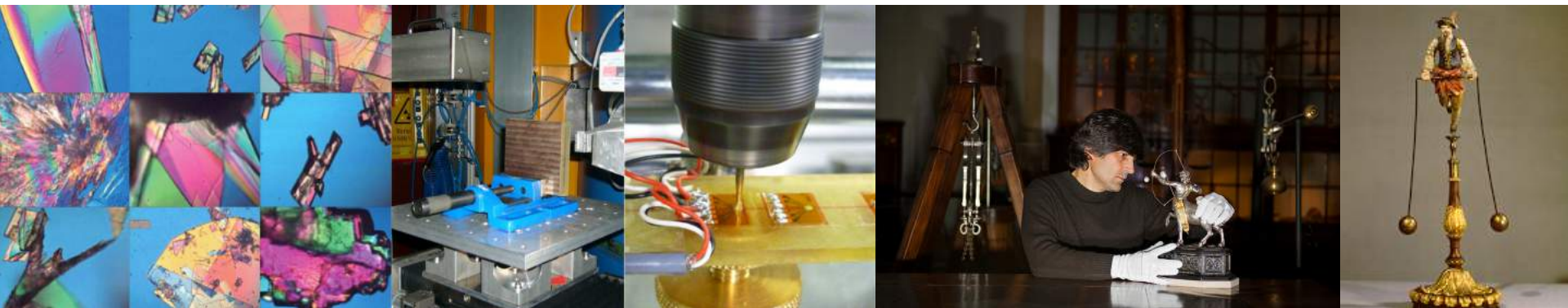

TRANSFERÊNCIA

Centro de competências em monitorização e controlo

Instrumentação para muografia geológica

Deteção de contrabando em contentores

Respiradores de emergência no início da pandemia

MISSÃO DO RÓMULO

Contribuir para a divulgação da cultura científica e tecnológica nacional;

Valorizar a riqueza inter e pluridisciplinar;

Aproximar a ciência de todos os tipos de público;

Motivar e atrair mais os jovens para a ciência



A **Biblioteca**

inserida no SIBUC - Serviço Integrado das Bibliotecas da Universidade de Coimbra
com acesso livre a documentos de diferentes áreas do
conhecimento e da cultura científica



...o **Rómulo** é um moderno centro de recursos para o ensino e aprendizagem das ciências e difusão da cultura científica:



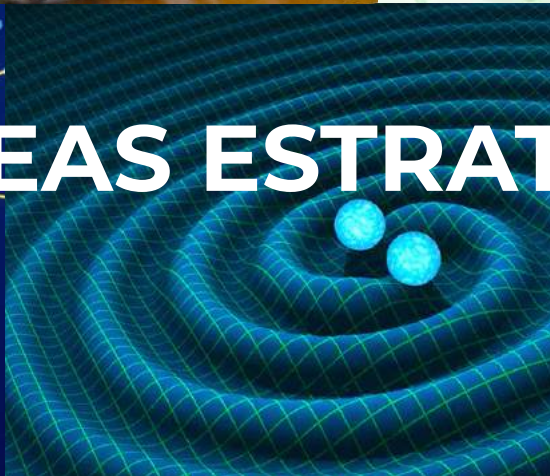
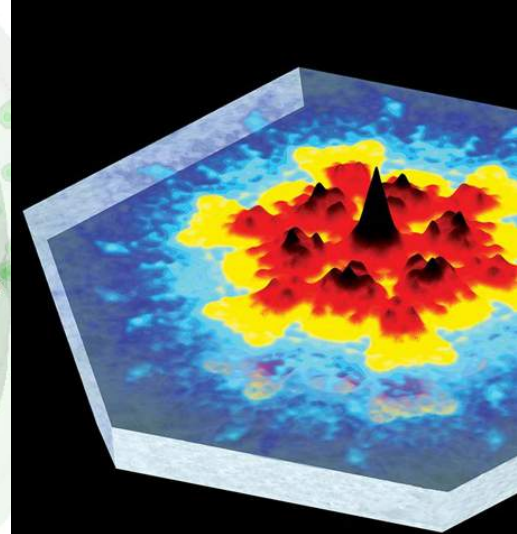
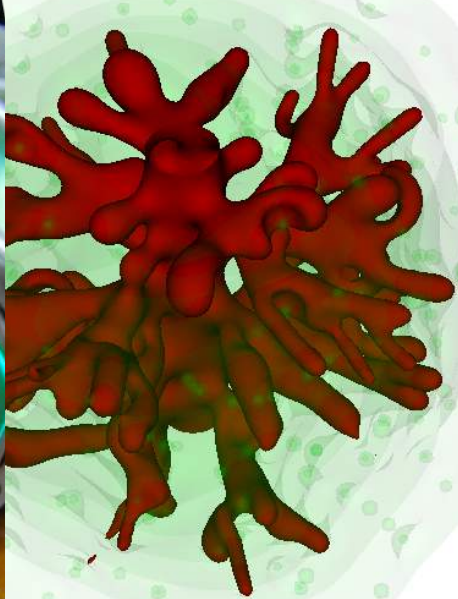
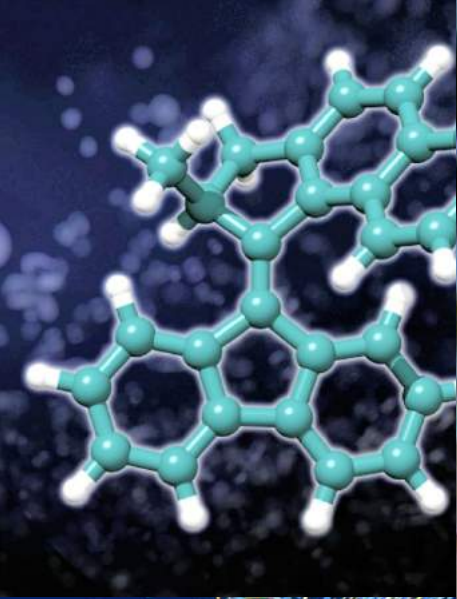

ÁREAS ESTRATÉGICAS

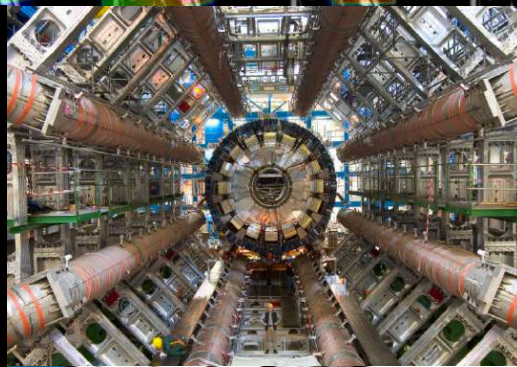
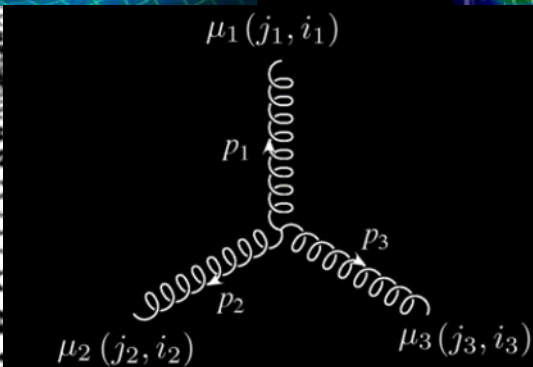
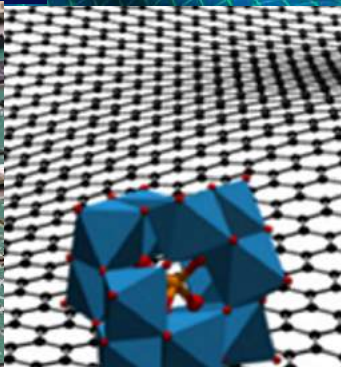
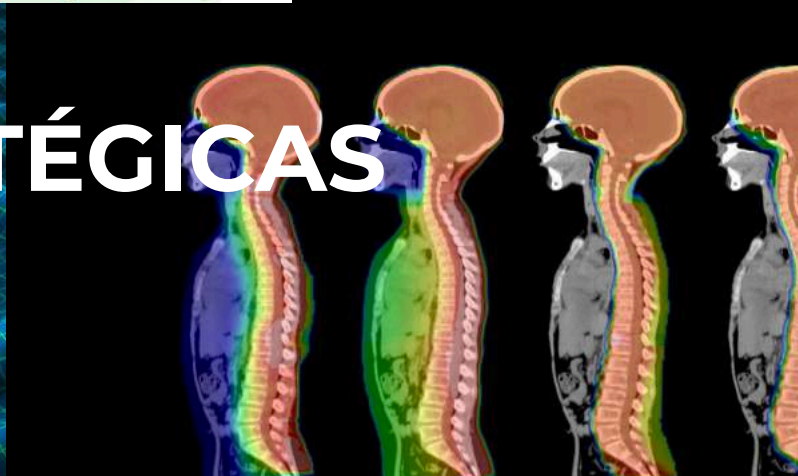

ÁREAS ESTRATÉGICAS



- * Instrumentação de ponta: detetores de radiação, tecnologias para a saúde
- * Materiais topológicos e materiais funcionais
- * Espectroscopia rotacional
- * Armazenamento de energia/ materiais para a energia
- * Crescimento patológico de vasos sanguíneos
- * Física de partículas: matéria escura, neutrinos, QCD, BSM
- * Espaço: SKA, Exoplanets, estrelas de neutrões, tecnologia para o espaço, Física solar, rede GeoPlanet
- * HPC
- * Muões
- * Automação e controlo
- * Sociedade, ensino pré-universitário



SUMMING UP

O Departamento de Física é um departamento multidisciplinar onde os saberes se cruzam, fortemente ligados aos outros departamentos da FCTUC e faculdades da UC e com forte internacionalização

O Departamento de Física está empenhado em

- Realizar investigação de excelência estabelecendo fortes colaborações internacionais
- Desenvolver instrumentação de ponta com aplicações variadas
- Criar um ambiente de ensino de excelência, atrativo para os estudantes, com espaço para a inovação e desenvolvimento de soft skills
- Abrir-se ao exterior através de outreach, colaboração com empresas, intervenção no património.

OBRIGADA!